

MAINTENANCE AND OPERATION  
INSTRUCTION MANUAL

# DB90-TX

IP Audio Encoder



# Contents

<b>Introduction</b> .....	<b>4</b>
<b>General Information</b> .....	<b>5</b>
<i>Application</i> .....	5
<i>Product Features</i> .....	6
<i>Technical Specifications</i> .....	7
<i>Block Diagram</i> .....	8
<b>Safety Precautions</b> .....	<b>9</b>
<b>Panel Indicators and Appointments</b> .....	<b>10</b>
<i>Front View</i> .....	10
<i>Rear View</i> .....	11
<b>Connecting of DB90-TX</b> .....	<b>12</b>
<i>Analog Audio Inputs</i> .....	12
<i>Digital Audio Input</i> .....	12
<i>LAN Port</i> .....	12
<b>Operation</b> .....	<b>13</b>
<i>Status</i> .....	15
<i>DB90-TX Configuration</i> .....	17
<i>Applying New Settings</i> .....	17
<i>Network Settings</i> .....	17
<i>WEB Server Settings</i> .....	18
<i>SNMP Settings</i> .....	18
<i>Audio Settings</i> .....	19
<i>Stream Server Settings</i> .....	20
<i>RTP Settings</i> .....	20
<i>Icecast Settings</i> .....	20
<i>Factory Defaults Settings</i> .....	21
<i>Network Default Settings</i> .....	22
<i>WEB Server Default Settings</i> .....	22
<i>SNMP Default Settings</i> .....	22
<i>Audio Default Settings</i> .....	22
<i>Stream Server Default Settings</i> .....	22
<i>RTP Settings</i> .....	22
<i>Icecast Settings</i> .....	22
<i>Hardware Reset</i> .....	23
<i>Network Default Settings</i> .....	23
<i>WEB Server Default Settings</i> .....	23
<i>Rebooting</i> .....	24
<i>Firmware Update</i> .....	25
<i>Connecting to the Stream Server</i> .....	26
<b>UPnP discovery in Local Networks</b> .....	<b>27</b>
<b>UPnP Activation</b> .....	<b>28</b>
<b>WARRANTY TERMS AND CONDITIONS</b> .....	<b>29</b>
<b>Product Registration Card</b> .....	<b>30</b>

THIS PAGE  
IS INTENTIONALLY  
LEFT BLANK

## Introduction

DEVA Broadcast Ltd. was established in 1997 as a broadcasting and telecommunications equipment importer for Bulgaria and Eastern Europe regions. Subsequently, DEVA Broadcast Ltd. has developed and produced a wide range of low and mid power transmitters, RDS/RBDS Encoders and Decoders, Modulation Monitors, Remote Controls, Site monitoring and other systems for many companies. Our high degree engineers accomplish their bright ideas through successful engineering, marketing and management in DEVA Broadcast Ltd.'s Headquarter in Bulgaria.

During the last ten years the company products have become our partners' best sellers. After detailed marketing analysis, our team has decided to launch its own brand products based on the latest technologies in the broadcasting business. The company's main goal is to design, develop and offer a complete line of high quality and competitive products for FM and Digital Radio, Radio Networks, Telecommunication Operators and regulation authorities. We base our market authority position on our good after sales support and relation with the clients.

Since 2003 DEVA Broadcast Ltd. has been ISO 9001 certified .

The contractors of DEVA Broadcast Ltd. are satisfied with the permanent business comfort and to their own confession they owe it to a great extent as well as their prosperity to the loyal partnership of our company.

## General Information

DB90-TX IP Audio Encoder is an integrated audio converter that converts audio signal into a high quality compressed audio stream. The signal can be compressed by HE-AAC, MPEG-1 Layer 3 encoder. DB90-TX also supports uncompressed PCM stream in order to ensure audio transmission without quality loss.

Compression is performed in real time, and the output signal is transmitted directly by IP-based networks. DB90-TX can work with both analog and digital audio signal. No matter how sophisticated, DB90-TX is located in a small and compact housing. All this allows you to quickly and painlessly integrate existing audio systems to the Internet. Developed with the thought of easiness of use, DB90-TX can be managed through a standard web browser, PC, PDA or other device.

## APPLICATION

---

- Audio broadcasting over IP-based networks.
- Point-to-Point Audio Transfer (DB90-RX IP Audio Decoder is required at the opposite site).
- Suitable for professional and consumer use.

## PRODUCT FEATURES

---

- High Quality HE-AAC (v.1 and v.2) and MPEG-1 Layer-3 Compression;
- 32 kHz, 44.1 and 48 kHz sample rates support;
- Up to 56 kbps bitrate for HE-AAC;
- Up to 320 kbps bitrate for MPEG-1 Layer-3;
- 6 LEDs and Phones output for quick diagnostics;
- IP address pronunciation at startup (through the headphones);
- Easy setup via a standard web browser;
- UPnP for easy discovery in Local Networks;
- Shoutcast/Icecast compatible TCP/IP stream;
- Status monitoring via SNMP
- Up to 10 simultaneously connected clients\*;

\* The actual limit depends on the speed of the link and/or other factors.

## TECHNICAL SPECIFICATIONS

<b>Audio codec</b>	
Codec	HE-AAC (v.1 and v.2), MPEG-1 Layer 3 or raw PCM
Sample rates	32, 44.1 and 48 kHz
Channels	1 or 2
Bitrate	Up to 56 kbps (HE-AAC); Up to 320 kbps (MPEG-1); Up to 1536 kbps (PCM);
<b>MPEG-1 Layer 3 specific</b>	
Encoding mode	Mono and stereo, Joint Stereo or Dual Channel
Emphasis	50µs, CCITT J.17 or none
<b>PCM codec</b>	
Channels	1 or 2
Bitrate	Up to 3072 kbps
<b>Analog audio input</b>	
Connector	2 x RCA, stereo
Type	Unbalanced
Level	+6dBu (max. +8dBu)
Sample rate	96 kHz; Build-in sample rate converter used to produce lower sample rates
Dynamic range	102 dB
<b>Digital audio input</b>	
Connector	RCA
Type	S/PDIF (IEC 60958)
Resampling	Thru build-in sample rate converter
<b>Phones audio output</b>	
Connector	1/8" (3.5mm) jack, stereo
Type	Headphones
<b>User interface</b>	
Indicators	6 LEDs on front panel
Web interface	Full control and status information
<b>Streaming server</b>	
Type	Shoutcast / Icecast compatible TCP/IP stream
Clients limit	Up to 10 simultaneous clients
<b>Network</b>	
Connector	RJ-45
Type	Ethernet
Device discovery	UPnP support
<b>Operating conditions</b>	
Temperature	10°C - 45°C
Humidity	< 75%, non-condensing
<b>Power requirements</b>	
Power supply	12V DC, 1A
<b>Size and weight</b>	
Dimension (W x H x D)	4,17" x 1,3" x 5" (106 x 33 x 128 mm)
Weight	0,44 lbs (0,2 kg)

## BLOCK DIAGRAM

---

A simplified block diagram of DB90-TX IP Audio Encoder is shown below

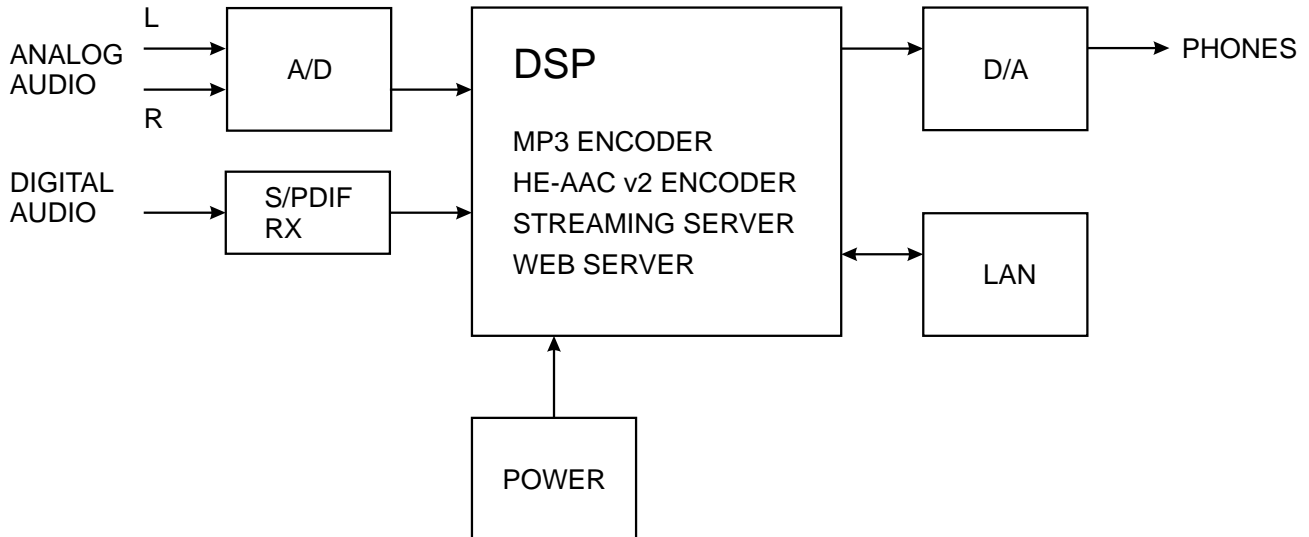

Because of the all-digital, minimalist-discrete-component nature of device circuitry, we have not provided schematic diagrams of the DB90-TX in this Manual. As they say on the back of TV sets:

**NO USER-SERVICEABLE COMPONENTS INSIDE.  
REFER ALL SERVICING TO  
QUALIFIED TECHNICAL PERSONNEL.**



## Safety Precautions

**IMPORTANT:** *Carefully read this paragraph as it contains important instructions concerning operator safety and directions regarding the installation, operation and maintenance of the equipment. Failure to observe the safety instructions and information given in this manual constitutes an infringement of the safety rules and design specifications provided for this piece of equipment. DEVA Broadcast Ltd. declines all responsibility if any one of the safety rules given herein is not observed. DEVA Broadcast Ltd. declines all responsibility if the end-user resells the product. The equipment is to be used by people capable of operating it in a trouble-free manner and it is assumed that they are aware of the following safety rules.*

- ◇ Keep this manual with the utmost care and close at hand so that it can be consulted whenever needed
- ◇ After unpacking the equipment, check it for condition.
- ◇ Avoid banging the equipment.
- ◇ The packing material (plastic bags, polystyrene, nails, etc.) must never be left within the reach of the children, as these items are potential sources of danger.
- ◇ Do not use the equipment in places where the temperature is not within the recommended range, as specified by the manufacturer.
- ◇ Before connecting the equipment, make sure the nameplate specifications correspond to the mains electricity supply (the nameplate is located on the equipment enclosure).
- ◇ Do not remove the sticker from the equipment as it contains important specifications and the relevant serial number.
- ◇ To join the equipment to the mains supply, use the power cord purchased with the equipment.
- ◇ The equipment must be used only for the purpose it was designed for.
- ◇ Abuse or misuse of the equipment is extremely dangerous for people, pets and property. The manufacturer declines all responsibility for damage and injury resulting from improper use and mishandling.
- ◇ Certain basic safety rules must be observed when using electrical equipment, in particular:
  - Never touch the equipment with wet and/or damp hands or other parts of the body.
  - Keep the equipment away from drops of water or sprinkling systems.
  - Never use the equipment near high heat sources or explosive material.
  - Do not introduce any extraneous matter into the equipment.
  - Do not allow children or untrained people to use the equipment.
- ◇ Before cleaning or servicing the equipment outside, disconnect it from the supply and wait at least 2 seconds before working on it, as recommended by current safety regulations.
- ◇ In the event of faults and/or improper operation, turn off the equipment, shut off the electrical power and call your dealer.
- ◇ Do not attempt to make repairs and/or adjustments when covers/guards or circuit boards are to be removed.
- ◇ Call your dealer for any repairs and be certain original spare parts are used. Failure to observe this rule may adversely affect the safety level of your equipment.
- ◇ The equipment is to be connected to the mains supply and provided with adequate and efficient earth conductors.
- ◇ When installing, leave a clearance of at least 1 cm around the equipment to allow air to pass freely.

## Panel Indicators and Appointments

### FRONT VIEW

---

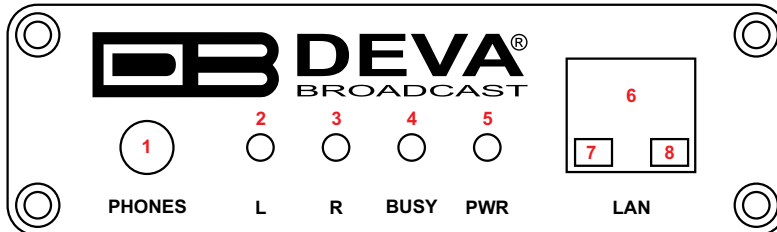

- 1 - Phones Output. The following audio signals are reproduced through the headphones:
  - Voice Announcement of DB90-TX IP Audio Encoder's IP address upon startup;
  - Audio signal from the selected input;
- 2 - Left Channel Level LED Indicator. This LED can be in one of the following states:
  - Off - the channel level is within norms;
  - Blinking – indication of low signal level;
  - Constantly lit – indication of high signal level;
- 3 - Right Channel Level LED Indicator. This LED can in one of the following states:
  - Off - the channel level is within norms;
  - Blinking – indication of low signal level;
  - Constantly lit – indication of high signal level;
- 4 - Connection LED Indicator. This LED can be in one of the following states:
  - Off - NO clients are connected to the encoder;
  - Blinking – at least one client is connected to the streamer;
  - Constantly lit – maximum allowable clients are connected to the streamer ([see “Stream Server Settings” on page 20](#));
- 5 - Power LED Indicator.
- 6 - LAN Port / Internet Input – standard RJ-45 port;
- 7 - Network Activity LED Indicator (RJ-45 built-in);
- 8 - Network Availability LED indicator (RJ-45 built-in);

## REAR VIEW

---

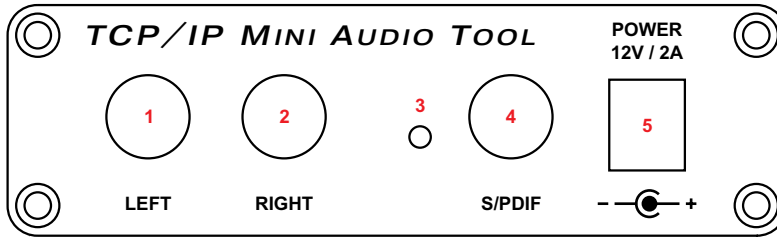

- 1 - Left Line Analog Input – standard RCA female jack;
- 2 - Right Line Analog Input – standard RCA female jack;
- 3 - Factory Defaults Reset button
- 4 - S/PDIF Input – standard RCA female jack;
- 5 - Power Supply (12 V, 1A);

## Connecting of DB90-TX

### ANALOG AUDIO INPUTS

---

Using a cable ending with two standard RCA jacks connect the analog signal source to the analog audio inputs of DB90-TX.

**WARNING:** Do not exceed maximum input level. This may permanently damage the device.

### DIGITAL AUDIO INPUT

---

Using a cable ending with a standard RCA jacks connect the S/PDIF signal source to the digital audio input of DB90-TX.

**NOTE:** As only one input can be managed by the encoder at certain point of time, please select the preferred signal source input – either analog or digital one. Selecting the preferred input can be performed under CONFIGURATION menu ([see “Audio Settings” on page 19](#))

### LAN PORT

---

For normal operation it is necessary the encoder to be connected to a local network or Internet by cable with RJ-45 connector.

## Operation

DB90-TX is controlled through the built-in web server and a standard web browser can be used to monitor its status or make some adjustments. To connect to the device you need to know its IP address and follow the next steps:

- Open a web browser.
- Enter the encoder's IP address in the browser's address field.
- Press <ENTER>.

If you do not know the encoder's IP address you can hear it through the headphones when you turn on DB90-TX. The other option to find out the IP address is using UPnP discovery in local networks ([see "UPnP discovery in Local Networks" on page 27](#)).

The web interface consists of the following pages:

- Status
- Configuration
  - Network
  - IP Audio
- Factory Defaults
- Reboot
- Firmware Update

At the top of each page is located the Navigational Menu and underneath, on the left side is the section with relevant information and adjustments. There is a kind of help section on the right side, containing brief information about each of the fields on the left.

Hover with your mouse over any of the left side fields to bring out a field's description next to the mouse pointer.

The picture below is illustrating STATUS page opened:



**NOTE:** As shown on the picture below a Username and Password may be requested if the Access Control is turned on and a page other than STATUS is selected (see “WEB Server Settings” on page 18). Defaults values are *user* and *pass*.

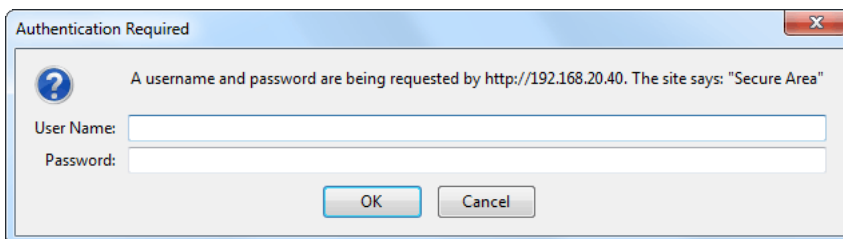

## STATUS

On the picture below is shown the page with current device status:



This page contains information regarding current DB90-TX IP Audio Encoder status as follows:

- Input Signal Level;
- Network Settings;
- List of Active Connections;

Level of the input signal and the list of active connections are updated dynamically which makes it possible to remotely monitor encoder's operation.

Under Network Status are shown MAC address and current IP address, Network mask and Gateway and the method in which they have been assigned:

- Static Allocation Settings
- Allocated by DHCP server
- Automatically generated

The last option uses AutoIP to generate a unique IP address. This option is activated automatically when the device is set to use DHCP server ([see “Network Settings” on page 17](#)), but such server is not available.

The list of Active Connections provides information for the currently connected clients. Shown are the IP address and local port of each client. Link duration is visible as well.

In the upper right corner is located LIVE DATA icon. Clicking on the icon will toggle live data ON and OFF as follows:



- live data is ON



- live data is OFF.



## DB90-TX CONFIGURATION

### Applying New Settings

In order new settings to take effect, it is necessary to press the SAVE button. Please keep in mind that some of the new settings can reset DB90-TX.



The screenshot shows the configuration page for the DB90-TX device. The top navigation bar includes 'Status', 'Configuration', 'Factory Defaults', 'Reboot', and 'Firmware Update'. The 'Configuration' section is active, with sub-tabs for 'Network' and 'IP Audio'. The 'Network' settings are divided into three main sections: General, WEB server, and SNMP. The 'General' section includes DHCP (Enabled), IP Address (0.0.0.0), Netmask (0.0.0.0), and Gateway (0.0.0.0). The 'WEB server' section includes Port (3101), Username (user), and Password (pass). The 'SNMP' section includes a 'Download' button for the MIB File, Agent (Disabled), Agent Port (161), Manager Port (162), Agent ID (1), Community (DEVA90), and Manager IP (0.0.0.0). A 'Save' button is located at the bottom of the form. On the right side, there are informational sections for 'Network settings', 'Web settings', and 'Web settings' (repeated), providing detailed descriptions and examples for each parameter.

### Network Settings

- DHCP – as DHCP Client is used to automatically obtain the Network Settings it can be enabled or disabled.
- IP Address – a field where static IP address is to be inserted in case that DHCP client is not used. Example: 192.168.0.2.
- Netmask – a field where Static Subnet Mask is to be inserted. This parameter is not used if DHCP Client is enabled. Example for Netmask is: 255.255.255.0.
- Gateway – a field where Static Gateway is to be inserted. This parameter is not used if DHCP Client is enabled. Example for Gateway is: 192.168.0.1.

**NOTE:** If the encoder's IP address is changed, it is necessary to enter the new IP address in your browser.

### **WEB Server Settings**

- Port – this is the TCP port of the WEB Server. Default value is 80.
- Username – user name for the WEB Server. Default value is user.
- Password – Password for the WEB Server. Default value is pass.

**NOTE:** You can define Username only, Password only or both of them. If both Username and Password are left blank, NO security is used.

### **SNMP Settings**

SNMP MIB File: Press the Download button to download DB90-TX SNMP MIB file.

**NOTE:** The MIB file may change from one firmware revision to the other. Downloading this file from the device ensures that you have the proper MIB file.

Specify Agent ID, Agent Port, Read/Write Communities, Manager IP and Manager Port.

**NOTE:** Agent ID is used to identify the device among others when a SNMP notification is send.  
Agent - enables/disables SNMP Agent.

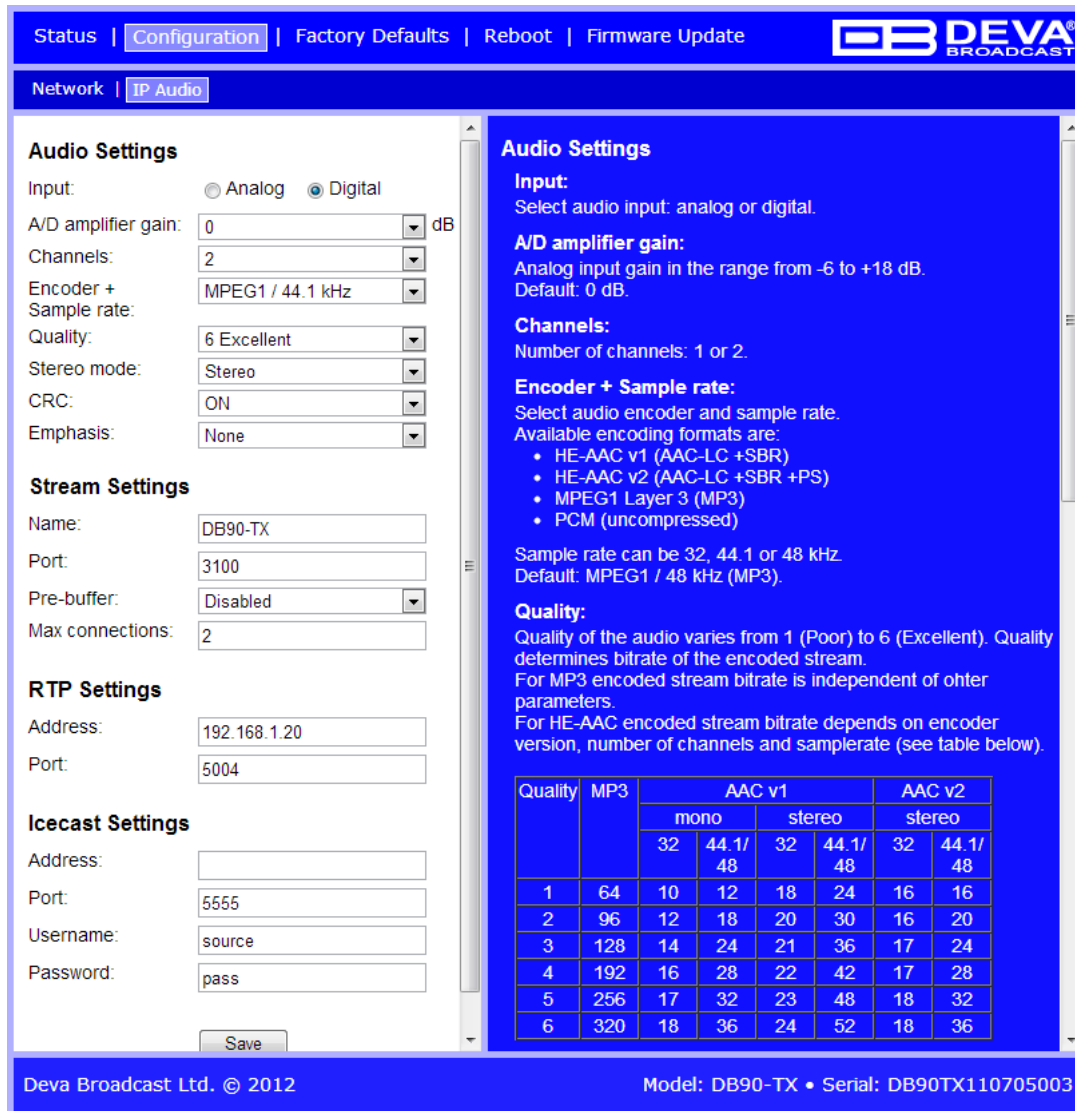

**Audio Settings**

Input:  Analog  Digital

A/D amplifier gain: 0 dB

Channels: 2

Encoder + Sample rate: MPEG1 / 44.1 kHz

Quality: 6 Excellent

Stereo mode: Stereo

CRC: ON

Emphasis: None

**Stream Settings**

Name: DB90-TX

Port: 3100

Pre-buffer: Disabled

Max connections: 2

**RTP Settings**

Address: 192.168.1.20

Port: 5004

**Icecast Settings**

Address:

Port: 5555

Username: source

Password: pass

**Audio Settings**

**Input:**  
Select audio input: analog or digital.

**A/D amplifier gain:**  
Analog input gain in the range from -6 to +18 dB.  
Default: 0 dB.

**Channels:**  
Number of channels: 1 or 2.

**Encoder + Sample rate:**  
Select audio encoder and sample rate.  
Available encoding formats are:

- HE-AAC v1 (AAC-LC +SBR)
- HE-AAC v2 (AAC-LC +SBR +PS)
- MPEG1 Layer 3 (MP3)
- PCM (uncompressed)

Sample rate can be 32, 44.1 or 48 kHz.  
Default: MPEG1 / 48 kHz (MP3).

**Quality:**  
Quality of the audio varies from 1 (Poor) to 6 (Excellent). Quality determines bitrate of the encoded stream.  
For MP3 encoded stream bitrate is independent of other parameters.  
For HE-AAC encoded stream bitrate depends on encoder version, number of channels and samplerate (see table below).

Quality	MP3	AAC v1				AAC v2	
		mono		stereo		stereo	
		32	44.1/48	32	44.1/48	32	44.1/48
1	64	10	12	18	24	16	16
2	96	12	18	20	30	16	20
3	128	14	24	21	36	17	24
4	192	16	28	22	42	17	28
5	256	17	32	23	48	18	32
6	320	18	36	24	52	18	36

Deva Broadcast Ltd. © 2012 Model: DB90-TX • Serial: DB90TX110705003

## Audio Settings

- Input – select analog or digital input to be used.
- A/D Amplifier Gain - Analog input gain in the range from -6 to +18 dB. Default level is 0 dB.
- Channels – select number of the input channels (1 or 2). If only one channel is selected, then the Left one is used.
- Encoder + Sample Rate – select audio encoder and sample rate.

Available encoding formats are:

- HE-AAC v1 (AAC-LC +SBR)
- HE-AAC v2 (AAC-LC +SBR +PS)
- MPEG1 Layer 3 (MP3)
- PCM (uncompressed)

- Quality – Audio quality varies from 1 (Poor) to 6 (Excellent). Quality determines bitrate of the encoded stream. For MP3 encoded stream bitrate is independent of other parameters. For HE-AAC encoded stream bitrate depends on encoder version, number of channels and sample rate (see table below):

Quality	MP3	AAC v1				AAC v2	
		mono		stereo		stereo	
		32 kHz	44.1/48 kHz	32 kHz	44.1/48 kHz	32 kHz	44.1/48 kHz
1	64	10	12	18	24	16	16
2	96	12	18	20	30	16	20
3	128	14	24	21	36	17	24
4	192	16	28	22	42	17	28
5	256	17	32	23	48	18	32
6	320	18	36	24	52	18	36

Please note all rates are in kbps.

**NOTE:** Quality does not apply to PCM stream. For PCM stream bitrate is calculated by the following equation: (sample rate)\*(Number of channels)\*16, [bps].

- Stereo mode – selecting stereo mode. Supported modes are Stereo, Joint Stereo or Dual Channels.

**NOTE:** This parameter applies only to MP3 stream.

- CRC - selecting whether MP3 stream to contain information on error detection.

Note: This parameter applies only to MP3 stream.

- Emphasis – selecting the emphasis to be applied. Supported values are 50µs, CCITT J.17 and NO emphasis.

**NOTE:** This parameter applies only to MP3 stream.

### Stream Server Settings

- Name – this is the encoder’s name displayed as name of the stream.
- Port – a field where TCP port of the stream server must be inserted. Default value is 5000.
- Pre-buffer – initial amount of data sent to the client. Large value decreases startup delay caused by buffering on the client side. This also introduces latency in the audio. Latency is bitrate dependent and can be estimated by the formula:  

$$\text{Latency} = (\text{PreBuffer} \times 8) / \text{BitRate}, [\text{sec}].$$
 Default value is 96k.
- Max connections – maximum number of simultaneous connected clients. This value can be in the range from 1 to 10. Default value is 2.

### RTP Settings

- Address – URL or IP Address of the RTP Receiver.
- Port – UDP port of the RTP Receiver.

### Icecast Settings

- Address – URL or IP Address of the Icecast Receiver.
- Port – TCP port of the Icecast Receiver.
- Username – Username for Authentication with Icecast Receiver.
- Password – Password for Authentication with Icecast Receiver.

## FACTORY DEFAULTS SETTINGS



On the above picture is shown the Factory Defaults page. Restoring DB90-TX to its Factory Defaults can be done by following the next steps:

- Press the “Restore” button.
- A new window as the one shown below will appear:

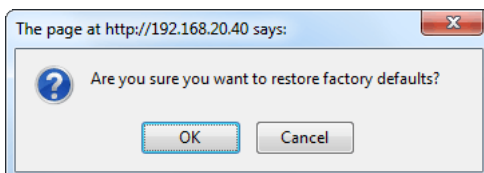

- Confirm that you want to restore factory defaults.
- Wait for the process to complete.

All the settings will be restored to their factory defaults except the Network Settings, which will remain the same.

On completion of the process DB90-TX settings will have the following values:

#### **Network Default Settings**

All General Network Settings will remain unchanged.

#### **WEB Server Default Settings**

All WEB Server Settings will remain unchanged.

#### **SNMP Default Settings**

- Agent : Disabled
- Agent Port: 161
- Community: DEVA90
- Manager IP: 0.0.0.0
- Manager Port: 162
- Agent ID: 0

#### **Audio Default Settings**

- Input: analog
- A/D amplifier gain: 0 dB
- Channels: 2
- Encoder + Sample rate: MPEG 1/48 kHz
- Quality: 6 Excellent
- Stereo mode: Stereo
- CRC: ON
- Emphasis: None

#### **Stream Server Default Settings**

- Name: DB90-TX
- Port: 5000
- Pre-buffer: 96k
- Max connections:2

#### **RTP Settings**

- Port: 5004

#### **Icecast Settings**

- Port: 5555
- Username: source
- Password: pass

## HARDWARE RESET

---

This process will fully restore DB90-TX to its Factory Defaults, including the Network settings. Hardware Reset can be done by following the next steps:

- Disconnect the power supply cable from the unit.
- Locate the RESET button on Rear panel.
- Press and hold the RESET button.
- Connect the power supply cable to the unit.
- Keep the RESET button hold until the POWER led starts blinking.
- Release the RESET button.
- Wait for DB90-TX to reboot with the factory default settings.

Upon completion of the process DB90-TX settings will have the following values:

### Network Default Settings

- DHCP: enabled

### WEB Server Default Settings

- Port: 80
- Username: user
- Password: pass

All other settings will have the factory default values described in chapter [“Factory Defaults Settings”](#).

**NOTE:** After the process completes the DHCP Client is enabled. The DB90-TX will obtain IP Address from DHCP server shortly.

**ATTENTION:** Please note that the WEB Server’s Port, Username and Password will be changed, so it is possible the page not to be loaded after restoring factory defaults. You may be asked to re-enter the encoder’s address and/or username and password.

## REBOOTING



On the above picture is shown the Reboot page. Rebooting of DB90-TX can be done by following the next steps:

- Press the “Reboot” button.
- The following warning window will appear:

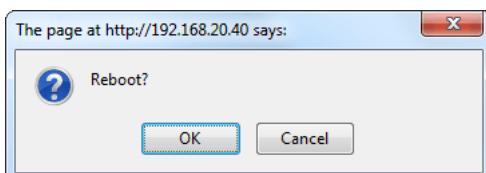

- Confirm that you want to reboot the encoder.
- Wait for the process to complete.



## FIRMWARE UPDATE

The screenshot shows a web browser window with a blue header. The header contains navigation links: Status | Configuration | Factory Defaults | Reboot | Firmware Update. The DEVA BROADCAST logo is in the top right. The main content area is split into two panels. The left panel, titled 'Firmware:', shows 'Main: v2.0.773, Apr 26 2012 15:23:53'. Below it, the 'Update Firmware:' section has a 'File:' label, an empty text input field, a 'Browse...' button, and an 'Upload' button. The right panel, titled 'Update Firmware', has a 'File:' label and the instruction 'Select firmware file to upload.' The footer of the browser window shows 'Deva Broadcast Ltd. © 2012' on the left and 'Model: DB90-TX • Serial: DB90TX110705003' on the right.

On the above picture is shown the Firmware Update page. To update the encoder's firmware, please follow the next steps:

- Select the new firmware file.
- Press the "Upload" button.
- The following warning window will appear:

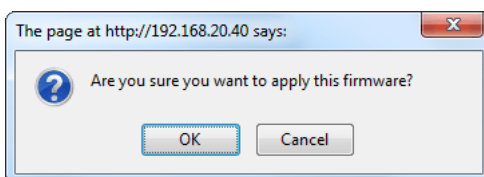

- Wait for the process to complete

## **CONNECTING TO THE STREAM SERVER**

---

To listen to the stream audio, please follow the next steps:

- Open an audio player supporting streaming audio
- Select “Play URL”
- Insert device’s address and port. For example: <http://192.168.0.2:5000/> .
- Wait to be connected

## UPnP discovery in Local Networks

DB90-TX implements UPnP which lets you easily find it in your local network. For this purpose your system should have UPnP enabled (see [“UPnP Activation”](#) on page 28). To discover the device follow the next steps:

- Connect the device to the local network.
- Open “My Network Places” on your computer.
- Find the decoder’s icon.
- Double click it to open the DB90-TX web interface.

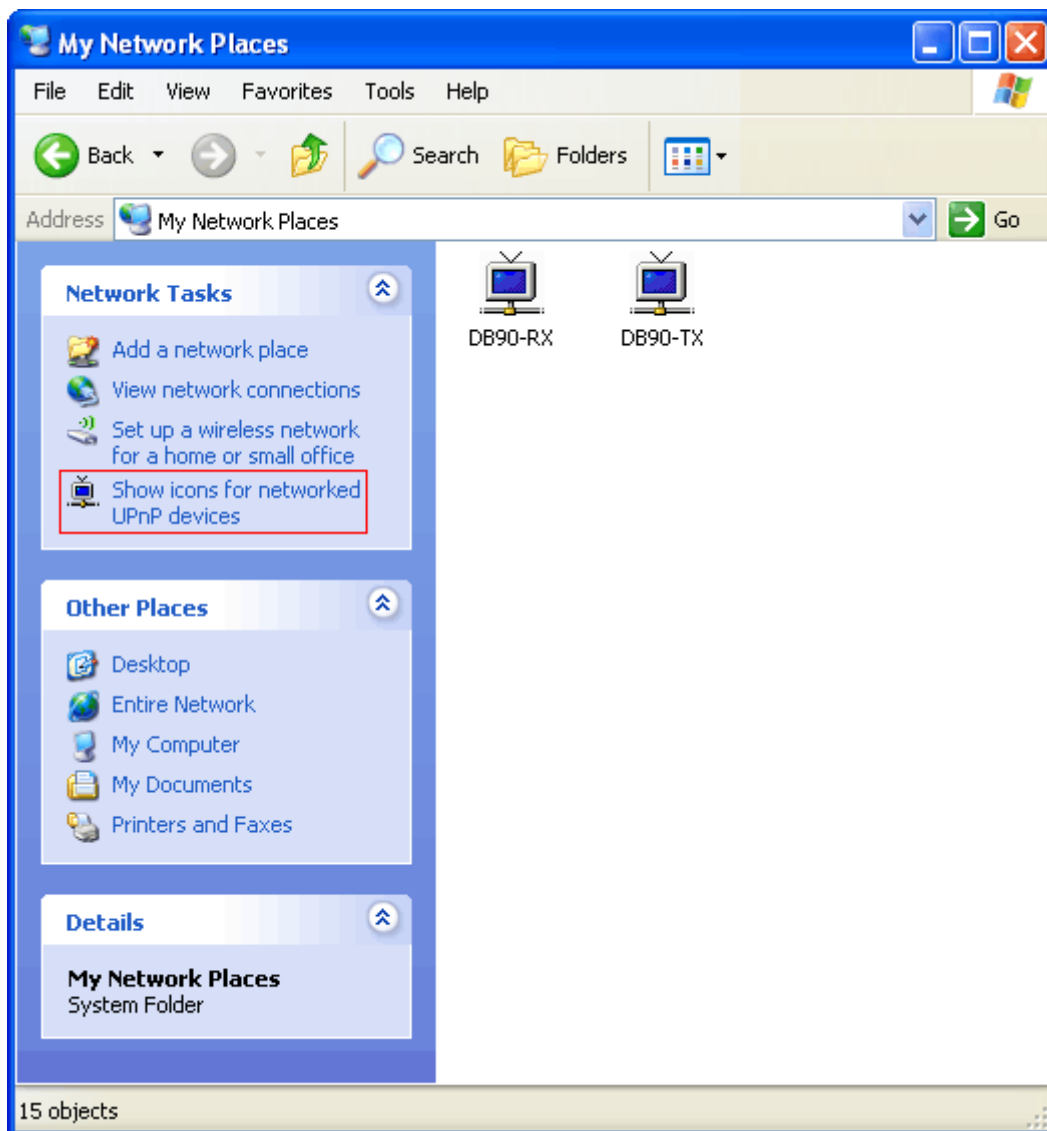

## UPnP Activation

**NOTE:** The following explanations apply to Windows XP SP2 or SP3! If you use another operating system, please contact your system administrator.

Open “My Network Places”. If you have the caption displayed in the picture below, click on it. Then click “Yes” and wait for the process to complete. Now you should see the device. If you still have troubles finding the device, please see

<http://support.microsoft.com/kb/941206> or contact your system administrator.

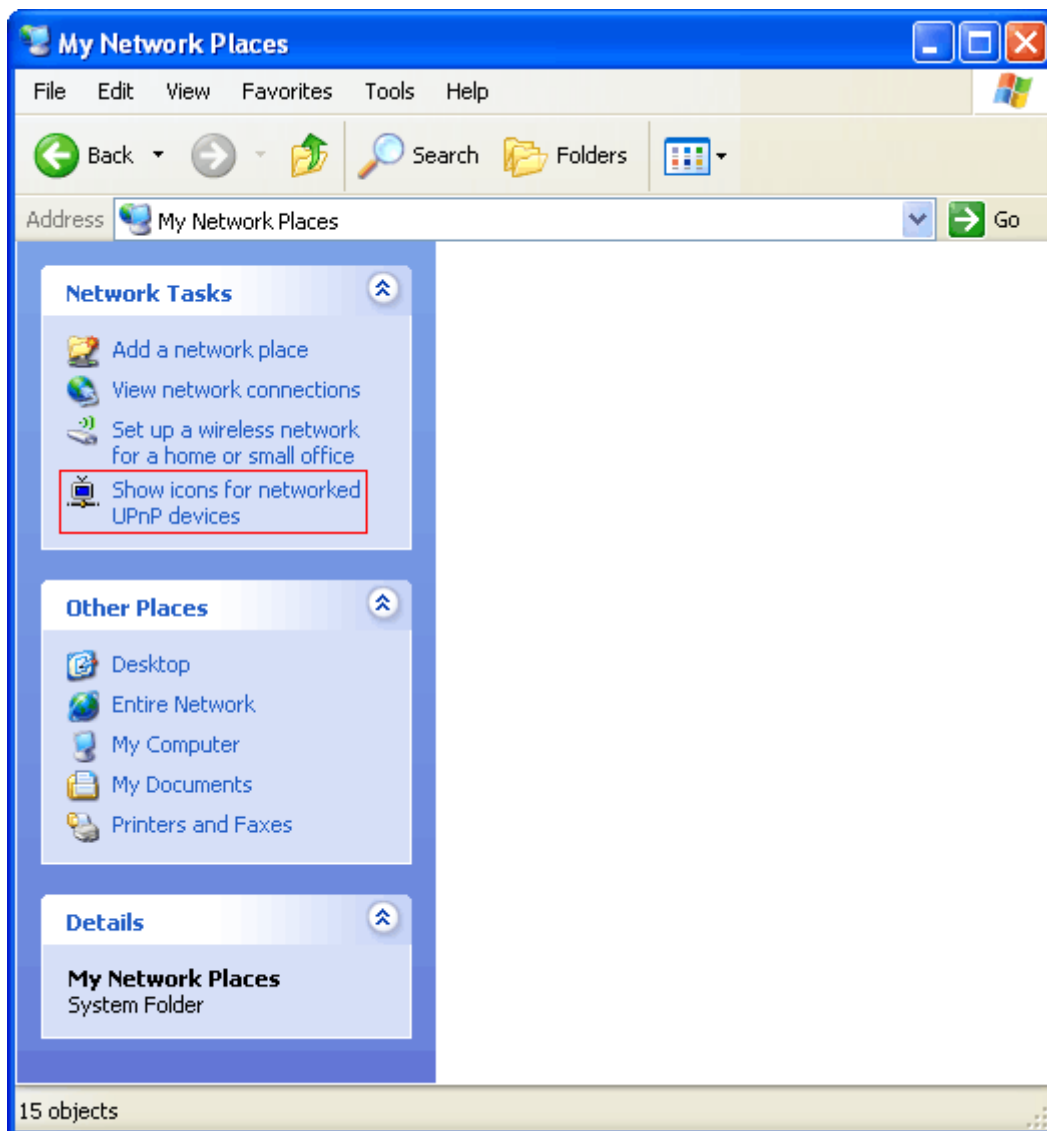

## WARRANTY TERMS AND CONDITIONS

**I. TERMS OF SALE:** DEVA Broadcast Ltd. products are sold with an understanding of “full satisfaction”; that is, full credit or refund will be issued for products sold as new if returned to the point of purchase within 30 days following their receipt, provided that they are returned complete and in an “as received” condition.

**II. CONDITIONS OF WARRANTY:** The following terms apply unless amended in writing by DEVA Broadcast Ltd.

**A.** The Warranty Registration Card supplied with this product must be completed and returned to DEVA Broadcast Ltd. within 10 days of delivery.

**B.** This Warranty applies only to products sold “as new.” It is extended only to the original end-user and may not be transferred or assigned without prior written approval by DEVA Broadcast Ltd.

**C.** This Warranty does not apply to damage caused by improper mains settings and/or power supply.

**D.** This Warranty does not apply to damage caused by misuse, abuse, accident or neglect. This Warranty is voided by unauthorized attempts at repair or modification, or if the serial identification label has been removed or altered.

**III. TERMS OF WARRANTY:** DEVA Broadcast Ltd. products are warranted to be free from defects in materials and workmanship.

**A.** Any discrepancies noted within TWO YEARS of the date of delivery will be repaired free of charge, or the equipment will be replaced with a new or remanufactured product at DEVA Broadcast Ltd. option.

**B.** Parts and labor for factory repair required after the one-year Warranty period will be billed at prevailing prices and rates.

### **IV. RETURNING GOODS FOR FACTORY REPAIR:**

**A.** Equipment will not be accepted for Warranty or other repair without a Return Authorization (RA) number issued by DEVA Broadcast Ltd. prior to its return. An RA number may be obtained by calling the factory. The number should be prominently marked on the outside of the shipping carton.

**B.** Equipment must be shipped prepaid to DEVA Broadcast Ltd.. Shipping charges will be reimbursed for valid Warranty claims. Damage sustained as a result of improper packing for return to the factory is not covered under terms of the Warranty and may occasion additional charges.

## PRODUCT REGISTRATION CARD

- All fields are required, or warranty registration is invalid and void

Your Company Name \_\_\_\_\_

Contact \_\_\_\_\_

Address Line 1 \_\_\_\_\_

Address Line 2 \_\_\_\_\_

City \_\_\_\_\_

State/Province \_\_\_\_\_ ZIP/Postal Code \_\_\_\_\_

Country \_\_\_\_\_

E-mail \_\_\_\_\_ Phone \_\_\_\_\_ Fax \_\_\_\_\_

Which DEVA Broadcast Ltd. product did you purchase? \_\_\_\_\_

\_\_\_\_\_  
\_\_\_\_\_

Product Serial # \_\_\_\_\_

Purchase date \_\_\_\_ / \_\_\_\_ / \_\_\_\_

Installation date \_\_\_\_ / \_\_\_\_ / \_\_\_\_

\_\_\_\_\_  
Your signature\*

\*Signing this warranty registration form you are stating that all the information provided to DEVA Broadcast Ltd. are truth and correct. DEVA Broadcast Ltd. declines any responsibility for the provided information that could result in an immediate loss of warranty for the above specified product(s).

**Privacy statement: DEVA Broadcast Ltd. will not share the personal information you provide on this card with any other parties.**