

MAINTENANCE AND OPERATION  
INSTRUCTION MANUAL

# SmartGen Micro

Basic RDS/RBDS Encoder  
with USB Connectivity



# Contents

<b>Introduction</b> .....	<b>5</b>
<b>General Information</b> .....	<b>6</b>
<b>Product Features</b> .....	<b>7</b>
<i>Technical Specifications</i> .....	8
<i>Block Diagram</i> .....	10
<i>Front Panel</i> .....	11
<i>Rear Panel</i> .....	12
<b>Before you start</b> .....	<b>13</b>
<i>Safety warning</i> .....	13
<i>Operating Recommendations</i> .....	14
<i>Radio Frequency Interference (RFI)</i> .....	14
<b>Unpacking and Inspection</b> .....	<b>15</b>
<b>Mounting</b> .....	<b>15</b>
<i>Heat Dissipation</i> .....	15
<b>RDS: Europe vs America</b> .....	<b>16</b>
<b>The RDS System</b> .....	<b>16</b>
<b>RDS Applications Supported</b> .....	<b>17</b>
<i>PI</i> .....	17
<i>PS</i> .....	17
<i>PTY</i> .....	17
<i>TA</i> .....	17
<i>TP</i> .....	18
<i>M/S</i> .....	18
<i>DI</i> .....	18
<i>AF</i> .....	18
<i>CT</i> .....	18
<i>RT</i> .....	18
<b>Selection of Operating Modes</b> .....	<b>19</b>
<i>Sidechain Mode</i> .....	19
<i>Loop-Through Mode</i> .....	19
<b>Connecting The SmartGen Micro</b> .....	<b>20</b>
<i>Important Connection Considerations!</i> .....	20
<i>Sidechain Mode (preferred)</i> .....	21
<i>Loop-Through Mode</i> .....	22
<b>Data Interconnection</b> .....	<b>23</b>
<i>USB Port</i> .....	23
<i>Computer or Terminal Requirements</i> .....	23
<b>Subcarrier Injection Level</b> .....	<b>24</b>
<i>Setting Subcarrier Amplitude</i> .....	24
<i>Subcarrier Phase</i> .....	25

<b>Programming Options .....</b>	<b>26</b>
<i>Simplified Windows® Data-Entry Software .....</i>	26
<b>Loading and Running The Simplified Software.....</b>	<b>27</b>
<i>Minimal System Requirements .....</i>	27
<i>Installing the Software .....</i>	27
<b>Installing The USB Port Driver under Windows® XP .....</b>	<b>28</b>
<b>Installing The USB Port Driver under Windows® 7 .....</b>	<b>30</b>
<b>Using the SmartGen Micro Manager.....</b>	<b>33</b>
<i>Sending &amp; Reading Data .....</i>	33
<i>Device Settings.....</i>	34
<i>Hardware &amp; RDS Configuration.....</i>	35
<i>Device Info .....</i>	35
<i>Encoder Mode .....</i>	35
<i>RDS Phase.....</i>	35
<i>PI Code Calculator .....</i>	35
<i>PTY Selection.....</i>	36
<i>TA Timeout.....</i>	36
<i>Dynamic PS.....</i>	36
<i>CT.....</i>	36
<i>RTC.....</i>	36
<i>RT Speed.....</i>	36
<b>File Management.....</b>	<b>37</b>
<b>Terminal Configuration .....</b>	<b>38</b>
<i>Serial Port Configuration .....</i>	39
<i>Power-Up .....</i>	41
<i>Echo .....</i>	42
<b>ASCII Programming Syntax .....</b>	<b>43</b>
<i>How to Type .....</i>	43
<i>Using ALL-CAPS .....</i>	43
<i>Correcting Mistakes .....</i>	43
<i>Validity Symbols .....</i>	44
<b>Encoder Housekeeping Commands .....</b>	<b>45</b>
<i>Register Interrogation .....</i>	45
<i>Encoder Initialization .....</i>	45
<i>Encoder Reset .....</i>	45
<i>Firmware Version .....</i>	45
<b>Listing of Encoder Commands and Prompts .....</b>	<b>46</b>
<b>Factory Defaults.....</b>	<b>47</b>
<i>General Settings.....</i>	47
<i>RDS Settings.....</i>	47
<b>Product Registration Card.....</b>	<b>48</b>
<b>WARRANTY TERMS AND CONDITIONS.....</b>	<b>49</b>
<b>APPENDIX A .....</b>	<b>50</b>
<i>PTY Code Description Used in RBDS Mode – North America.....</i>	50
<b>APPENDIX B .....</b>	<b>51</b>
<i>PTY Code Description Used in RDS Mode – Europe, Asia .....</i>	51

THIS PAGE  
IS INTENTIONALLY  
LEFT BLANK

## Introduction

DEVA Broadcast Ltd. was established in 1997 as a broadcasting and telecommunications equipment importer for Bulgaria and Eastern Europe regions. Subsequently, DEVA Broadcast Ltd. has developed and produced a wide range of low and mid power transmitters, RDS/RBDS Encoders and Decoders, Modulation Monitors, Remote Controls, Site monitoring and other systems for many companies. Our high degree engineers accomplish their bright ideas through successful engineering, marketing and management in DEVA Broadcast Ltd.'s Headquarter in Bulgaria.

During the last ten years the company products have become our partners' best sellers. After detailed marketing analysis, our team has decided to launch its own brand products based on the latest technologies in the broadcasting business. The company's main goal is to design, develop and offer a complete line of high quality and competitive products for FM and Digital Radio, Radio Networks, Telecommunication Operators and regulation authorities. We base our market authority position on our good after sales support and relation with the clients.

Since 2003 DEVA Broadcast Ltd. has been ISO 9001 certified .

The contractors of DEVA Broadcast Ltd. are satisfied with the permanent business comfort and to their own confession they owe it to a great extent as well as their prosperity to the loyal partnership of our company.

## General Information

SmartGen Micro Encoder is the quick and inexpensive way to have an RDS/RBDS presence. The SmartGen Micro is able to transmit basic RDS information such as the Program Service name(PS), Program Identification(PI), Alternative Frequencies(AF), Program Type(PHY). Decoder Information and Music / Speech flag are also supported. USB connectivity makes it easy to program the non-volatile memory using any PC and the supplied Windows® software. After programming, the unit may be disconnected and re-installed at the transmitter site. Though it is not capable of “dynamic” messaging with song titles, SmartGen Micro will identify your station by format, display your station’s “street name”, and continuously transmit any station promo or advertising message to your listeners.

## Product Features

- Very Attractive Price
- Very Good Price-Performance Ratio
- PS & Radio Text Scrolling Options
- Fully Digital Synthesis of RDS signal
- MPX Loopthrough & Sidechain Modes
- Internal or external Pilot / MPX Synchronisation
- Very Intuitive Windows Configuration Software
- Proved and reliable hardware for 24/7/365 operating
- Built-in dedicated 19kHz source for internal sync
- Works with any FM exciter and stereo generator
- Supports both RDS & RBDS standards
- Easy Installation and Setup
- USB Programming Interfaces
- Built-in failsafe bypass relay
- Robust Aluminum Case for high RF immunity

## TECHNICAL SPECIFICATIONS

TECHNICAL SPECIFICATIONS	
Chassis Dimensions	4.72" x 4.06" x 1.2", 120 x 103 x 31mm
Shipping Weight	1kg
Power Supply	External, 12V / 1A
Pilot/MPX Input	Yes
MPX/RDS Output	0 to 3199 mV p-p
Communication Port	USB
Synchronization	External (Pilot or MPX); Internal; Auto
RDS Level adjustment	with trim pot
Phase adjustment	Yes
Side Chain Mode, Loop through mode, Bypass feature	Yes
RDS Subcarrier	100% Digitally Generated Shape
Pilot synchronization	Input Level: -50dBu to +12dBu Frequency: 19kHz, ±3Hz
EN50067 compliant	Yes
Firmware can be upgraded in the field	Yes
Operating Temperature	0°C ÷ 55°C
RDS FEATURES	
Group supported	0A, 2A, 4A
Group Sequence	Fixed
PS	1
PI	1
PTY	RDS/RBDS
AF Method A	7
AF Method B	No
RT	Yes, 1 messages
RT rate adjustment	Yes
TP	Yes
TA Control	Software
CT	Yes
64-character Dynamic PS shown on all RDS/RBDS Radios	Yes
Auto "parses" long messages for best text display	Yes
Scrolling by character	from 1 up to 8
Scrolling by word, Auto centering, Truncate long words	Yes



<b>COMMUNICATION</b>	
Communication Interfaces	USB
Connection with Automation Software	No
Configuration	Software
Password Protection	No
ASCII Protocol	Yes
PI <=> CALL Calculator	Yes
Supplied with Intuitive Software	Yes
Comes with 2-years Limited Warranty	Yes

## BLOCK DIAGRAM

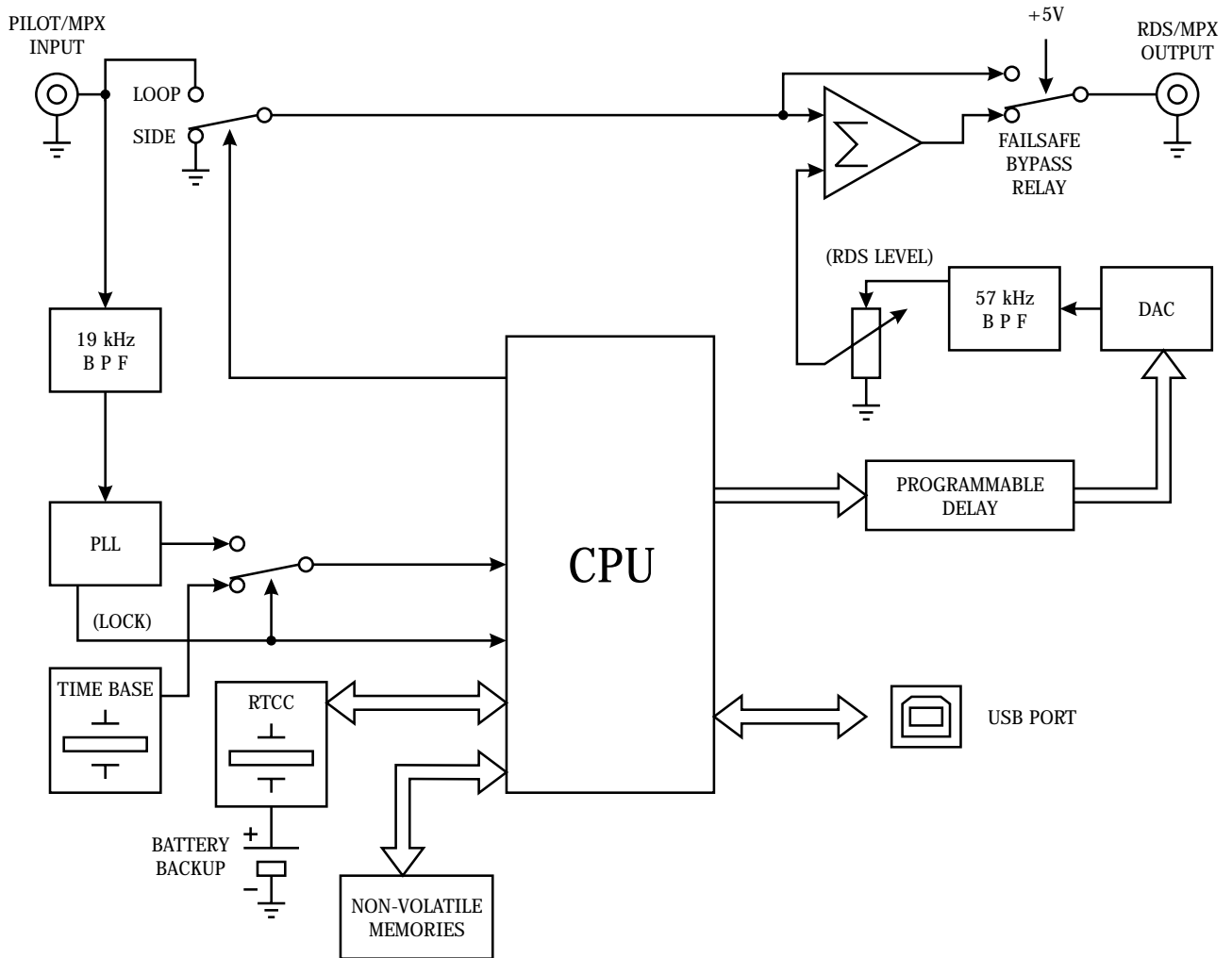

## FRONT PANEL

---

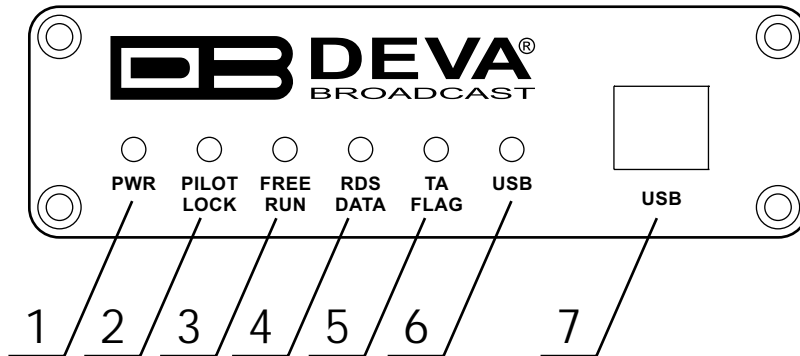

1. **PWR** - This LED lights whenever DC voltage is present.
2. **PILOT LOCK** - This LED lights when the encoder has locked to the 19kHz stereo pilot signal from the stereo generator, either in the sidechain or the loop-through mode of encoder operation.
3. **FREE RUN** - When no 19kHz pilot is present at the PILOT OR MPX INPUT, the encoder defaults to a crystal-controlled internal timebase. This enables RDS transmissions with monaural programming. The FREE RUN LED shows that the encoder has defaulted to its internal timebase.
4. **RDS DATA** - This LED flashes dimly as RDS data is being transmitted, serving as an indication that the encoder is operating normally. Even when no dynamic data is being sent, the various RDS groups of static identifiers are updated continually.
5. **TA FLAG** - This LED flashes whenever the TA flag is raised. **REMEMBER:** the TA flag is only temporary. It must be turned off as soon as the announcement ends.
6. **USB** - This LED lights when the USB port is addressed.
7. **USB Connector** - B-Type, for interconnection with PC

## REAR PANEL

---

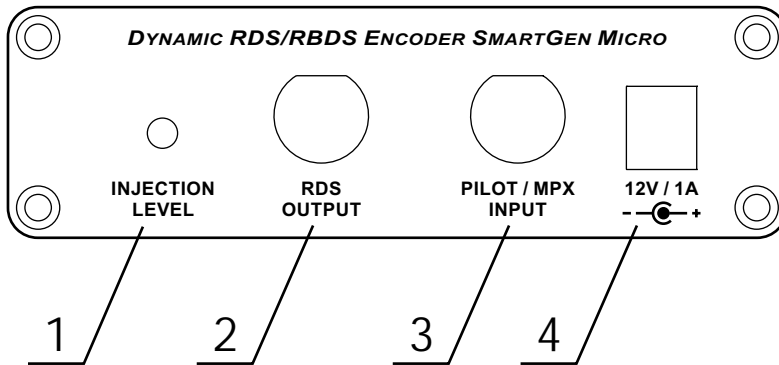

- 1. INJECTION LEVEL** - This multi-turn adjustment sets the RDS subcarrier output level, which is adjustable between 0 and 3199 mV. ([see “Subcarrier Injection Level” on page 24](#))
- 2. RDS/MPX OUTPUT** - BNC Connector for RDS/MPX output signal
- 3. RDS/MPX INPUT** - BNC Connector for RDS/MPX input signal
- 4. POWER SUPPLY** - 12V DC/ 1A, Power Jack 1/4” (6,3 mm)

## Before you start

### SAFETY WARNING

---

After removing any housing parts and electronic assemblies it is possible to get access to live parts. It is essential to ensure that the subsequent safety rules are strictly observed:

- Servicing of electronic equipment must be performed by qualified personnel only.
- Before removing covers the equipment has to be switched off and the mains cable unplugged.
- When the equipment is open the power supply capacitors have to be discharged by the help of a suitable resistor.
- During servicing unprotected and operating equipment:
  - never touch bare wires or circuitry.
  - use insulated tools only.
  - never touch metal semiconductor cases because they may carry high voltages.
- For removing and installing electronic components, please follow the recommendations concerning the handling of MOS components.

## **OPERATING RECOMMENDATIONS**

---

For the normal and reliable operation of the SmartGen Micro device we recommend to follow the next list of instructions:

- Please, install the unit only in places with good air conditioning. The unit has been designed for operation within an ambient temperature range extending from 10 to 50°C. But because adjacent, less efficient equipment may radiate substantial second-hand heat, be sure that the equipment rack is adequately ventilated to keep its internal temperature below the specified maximum ambient. When installing, leave a clearance of at least 1 cm around the equipment to allow air to pass freely.
- We do not recommend installation in rooms with high humidity, dusty places or other aggressive conditions.
- Although it is expected that a SmartGen Micro will be installed close to exciters (or transmitters of even higher-power!), please practice reasonable care and common sense in locating the unit away from abnormally high RF fields.
- Please, use only already checked power supply cables and sources. The shielded cables usage is strongly recommended.
- We strongly recommend connecting the device only to reliable power supply sources. In case of unstable power supply, please use UPS (Uninterruptible Power Supply).
- Please, use the device only with placed top cover to avoid any electromagnetic anomalies which may cause problems of the normal functionality of the unit.
- Please, connect SmartGen Micro only to good quality Internet connection. This is very important for the normal remote operation of the unit.
- Please, check if your network settings pass through all the data traffic required for the normal operation of the SmartGen Micro unit.

## **RADIO FREQUENCY INTERFERENCE (RFI)**

---

Although we have anticipated SmartGen Micro installation in the immediate proximity of broadcast transmitters, please do practice some care using the unit away from abnormally high RF fields.

## Unpacking and Inspection

**IT IS VERY IMPORTANT** that the Warranty Registration Card found at the front of this Manual be completed and returned. Not only does this assure coverage of the equipment under terms of the Warranty and provide a means of tracing lost or stolen gear, but the user will be sent specific SERVICE OR MODIFICATION INSTRUCTIONS issued by DEVA Broadcast Ltd.

As soon as the equipment is received, inspect carefully for any shipping damage. If damage is suspected, notify the carrier at once, and then contact DEVA Broadcast Ltd.

We recommend that you retain the original shipping carton and packing materials, just in case return or reshipment becomes necessary. In the event of return for Warranty repair, shipping damage sustained as a result of improper packing for return *may invalidate the Warranty!*

## Mounting

### HEAT DISSIPATION

---

Consuming less power than the light in a refrigerator, the SmartGen Micro itself generates negligible heat. The unit is specified for operation within an ambient temperature range extending from freezing to 120°F/50°C. But because adjacent, less efficient equipment may radiate substantial heat, be sure that the equipment rack is adequately ventilated to keep its internal temperature below the specified maximum ambient.

## RDS: Europe vs America

The European Broadcasting Union (EBU) and its member countries originated the concept of “Radio Data” transmission. The European RDS specification, CENELEC Standard EN50067, was first published in 1984. It was revised in 1986, 1990, 1991 and 1992.

European RDS has grown in use following initial adoption of the Standard. RDS is nearly universal throughout Europe; it is almost impossible to find a European FM broadcasting station that does not carry a radio data subcarrier.

The popularity of RDS in Europe is very much in contrast with initial reluctance on the part of US broadcasters to embrace this technology. This can be ascribed to material differences in broadcasting practices.

Almost without exception, FM broadcasting in the United States is ‘detached’ and independent; that is, each station originates its own programming. One exception might be America’s National Public Radio, though for most of the broadcast day even NPR stations originate, or at least schedule, their own programs.

Much of European broadcasting is similar to the concept of network radio that was common in the US prior to the 1950s. In Europe, a central program originator may have many transmitting facilities of modest power situated throughout the country, at several different frequencies to blanket a designated service area. The European disposition toward lower-power transmitters can be found on the “local radio” level as well.

The European concept of a service area equates to the US broadcaster’s market. The subtle difference between these designations further characterizes broadcasting practices and ethics. RDS benefits the European broadcaster through almost an altruistic endeavor to be of service to his listeners. The US broadcaster is marketing his programming, and is primarily interested in how he can create additional revenue from RDS.

## The RDS System

RDS is a digital data channel transmitted as a low-level subcarrier above the range of the composite stereo program signal in the FM baseband. The data transmission (baud) rate is comparatively low, yet it is quite robust because of data redundancy and effective error correction.

It is not within the scope of this Manual to cover the details of RDS subcarrier coding and modulation. For this the reader is directed to the Specification appropriate to his location, either the CENELEC EN50067 Specification for Europe, or the United States NRSC Specification. It is assumed that the user has some familiarity with the concept of RDS, since the balance of this Manual will deal with specific implication of RDS implemented with the SmartGen Micro.



## RDS Applications Supported

The following is an alphabetical listing of RDS applications that are fully supported by the SmartGen Micro. The standardized RDS application abbreviation is followed by an expansion of the application name and a short explanation of the function.

### PI

---

**Program Identification:** This block of data identifies the broadcast station with a hexadecimal numerical code, which becomes the “digital signature” of the station. The code is assigned by the broadcasting authority in most countries, but in the US it is calculated from a numerical encoding of station call letters. The receiver processes the PI code to assist automatic tuning features (station memories), and to prevent false switching to alternative frequencies that might be shared by broadcasters in nearby regions.

### PS

---

**Program Service Name:** This is the station’s “street name” that will appear on the receiver faceplate display. The PS can be up to eight characters in length (including spaces) and can be as simple as the station’s call letters: KWOW or KWOW FM, or a slogan: NEWSTALK or LIVE 95. The Program Service Name is automatically displayed, even on automobile receivers, and because of driving safety considerations broadcasters are generally discouraged from scrolling messages in this field. As a matter of fact, it is a violation of both the CENELEC and the NRSC standards to scroll the PS display, although the practice has become universally common.

### PTY

---

**Program Type:** The PTY data flag identifies the station format from a collection of pre-defined categories. Many RDS receivers are able to seek the listener’s preferred format automatically. This means that a car radio can switch from a fading station to a stronger one that carries the same variety of music, though not the very same program, as provided by AF switching. The PTY function of RDS helps a broadcaster catch ‘transient audience’ share. A listing of the PTY categories is given in [“APPENDIX A” on page 50](#) and [“APPENDIX B” on page 51](#).

Under some programming circumstances, the PTY identifier may be made ‘dynamic,’ changing between categories for a station that “dayparts” (changes its format for specific time periods). The PTY code is not meant to change from song to song or to accommodate a top-of-the-hour newscast, however.

### TA

---

**Traffic Announcement:** This is a temporary flag added to the RDS data stream only as a traffic bulletin is being aired. Some RDS car radios can be set to search for traffic bulletins among various TP stations (see TP below) while tuned to a listener’s preferred program, or even while playing a tape or CD. As soon as any TP station broadcasts a traffic bulletin, the receiver temporarily switches-over to receive it. When the bulletin is finished, the receiver switches back to the original program, tape or CD.

## TP

---

**Traffic Program Identification:** The TP flag identifies the station as one that routinely broadcasts traffic bulletins for motorists as part of its normal, everyday programming. When the TP flag is displayed on the receiver faceplate, the radio is searching for traffic announcements. The radio keeps track of TP stations offering this service to speed up the search-and-switch process.

## M/S

---

**Music / Speech Switch:** This flag simply indicates whether music or speech is the primary broadcast programming. The purpose of this function is not well explained in the respective Standards; hence it comes as no surprise that it is not widely used.

## DI

---

**Decoder Information:** This is one of several 'flags' that convey yes/no or other very basic data. This particular flag tells the receiver whether the broadcast is monaural, or is being transmitted in any of several methods of stereo or binaural broadcasting. As many as 16 encoding options may be accommodated! This is a rather esoteric function and, thus far, remains unused both in Europe and in the US.

## AF

---

**List of Alternative Frequencies:** A network broadcaster, or one with low-power rebroadcast transmitters (translators) to fill holes in his coverage area, can include a list of all frequencies where the identical program can be heard simultaneously. The RDS receiver (particularly the upscale car radio) constantly searches for the best signal that carries the very same program. When a better signal is found, the radio re-tunes with no noticeable interruption. The principal utility of this RDS function is with European radio networks and US stations with 'translators.'

## CT

---

**Clock Time and date:** Time and date codes should use Coordinated Universal Time (UTC) and Modified Julian Day (MJD). If MJD = 0 the receiver should not be updated. The listener, however, will not use this information directly and the conversion to local time and date will be made in the receiver's circuitry. CT is used as time stamp by various RDS applications and thus it must be accurate.

## RT

---

**RadioText:** This is a 64-character block of plain text that the listener can select for visual display on the faceplate of the radio by pressing an INFO button on the receiver. This function is not available on many automobile radios for safety reasons, which has precipitated the frowned-upon practice of scrolling the PS field instead.

Most radios have limited alphanumeric display capability, so the 64 characters of RadioText march across the front panel, much akin those annoying LED advertising signs found in airport buses or fast food emporia. Like the scrolling-PS implementation, RadioText can announce song titles and performers, run special promotions or contests, or broadcast sponsors' messages.

## Selection of Operating Modes

### SIDCHAIN MODE

---

Configured for sidechain operation, the rear-panel PILOT OR MPX INPUT connector simply bridges (monitors) the output of the stereo generator to derive timing information from the 19kHz stereo pilot. Alternatively, a TTL-level 19kHz sync squarewave may be applied to this input. We do not recommend this, however, as the phase relationship between the synchronizing squarewave and the 19kHz pilot component in the composite, multiplex output of the stereo generator may not be assured.

In sidechain operation the RDS OR MPX OUTPUT will contain only the RDS subcarrier, the composite/MPX signal is *not* routed through the SmartGen Micro. This operating mode best preserves multiplex signal integrity and assures uninterrupted program transmission in the event of a catastrophic encoder failure (very doubtful). As delivered, the SmartGen Micro is configured for sidechain operation.

### LOOP-THROUGH MODE

---

When the SmartGen Micro is configured for loop-through operation, the RDS subcarrier is internally combined with the composite/MPX signal. This means that the RDS OR MPX OUTPUT *will include* the composite/MPX program signal (at unity gain) with the RDS subcarrier added. Also, in the loop-through mode the internal bypass relay will pass-through the multiplex signal in the event of an encoder power failure.

## Connecting The SmartGen Micro

### **IMPORTANT CONNECTION CONSIDERATIONS!**

The SmartGen Micro encoder must be properly configured for the desired operating mode: sidechain or loop-through before it is installed in the signal path. Use SmartGen Basic Encoder Manager (see [“Hardware & RDS Configuration”](#) on page 35) to confirm that the encoder is properly configured before connecting the SmartGen Micro to other air-chain equipment.

Also, it is important that the operating software be installed on the PC before it is connected to the encoder for programming the ‘static’ message registers and operating defaults. In addition, we heartily recommend testing the encoder with its controlling interface (computer, terminal, automation, etc.) before it is placed in the air chain. This will ensure that 2-way communication with the encoder can be established and that the encoder is properly initialized.

## SIDCHAIN MODE (PREFERRED)

Attach a BNC 'T' adapter to the composite/MPX output of the stereo generator as shown in Figure below. Connect one side of the 'T' directly to a wideband (composite/ MPX) input of the FM exciter and the other side to the PILOT OR MPX INPUT of the SmartGen Micro. (This is only a bridging 'sync' connection when the circuit board has been jumpered for sidechain operation and does not affect the composite/MPX signal.)

If the stereo generator has a dedicated 19kHz TTL-level output designated for RDS encoder sync, you may connect this to the encoder PILOT OR MPX INPUT. We do not recommend this, as a dedicated 19kHz sync output may not have the proper phase relationship with the stereo pilot.

Cable the RDS OR MPX OUTPUT of the encoder to a second wideband (subcarrier) input of the FM exciter.

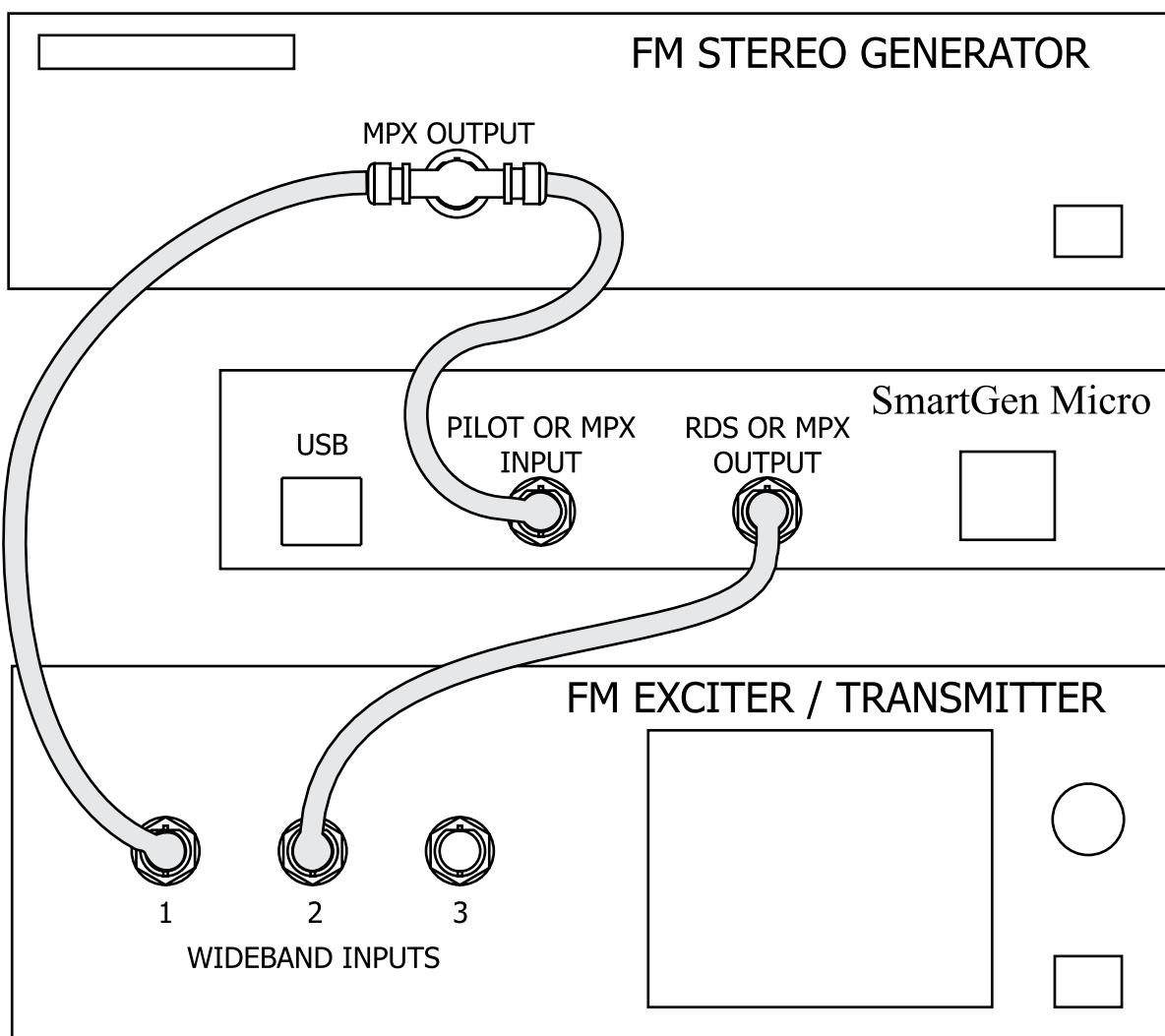

**“Sidechain” Encoder Connection**

## LOOP-THROUGH MODE

In the loop-through mode, the output of the stereo generator is cabled directly to the PILOT OR MPX INPUT of the SmartGen Micro as shown in Figure below. Connect the RDS OR MPX OUTPUT of the encoder to a composite/MPX wideband input of the FM exciter. When configured for loop-through operation, the composite/MPX signal *passes through* the encoder with unity gain, and with the RDS subcarrier added.

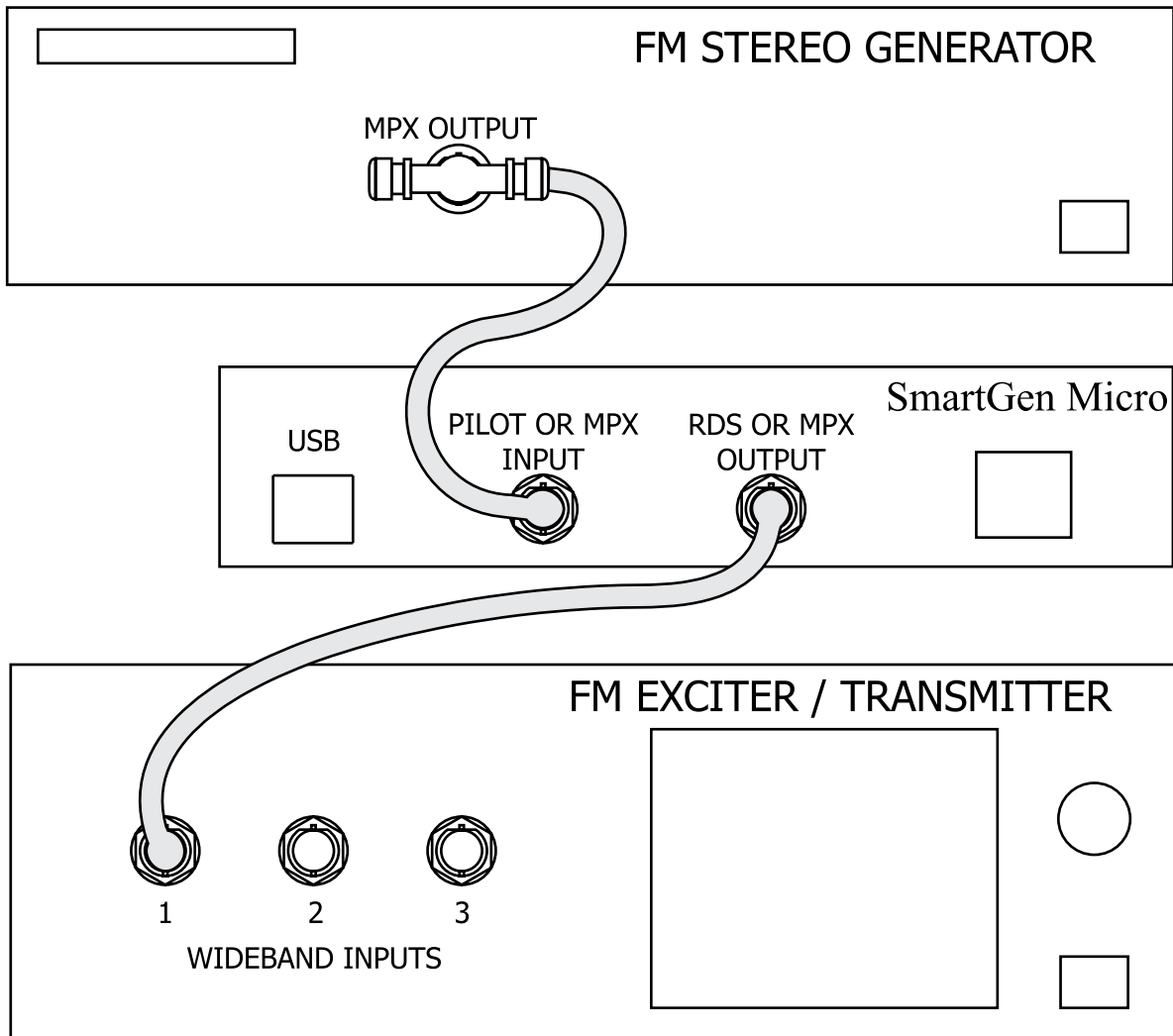

**Loop-Through Encoder Connection**

## Data Interconnection

### USB PORT

---

Front-panel USB port, convenient for setting service flags and entering static RDS data

**NOTE:** For USB interface with a PC for local programming of the ‘static’ data registers, software must be installed on the computer *before* it is connected to the encoder. Refer to software installation instructions beginning in section [“Programming Options”](#) on page 26.

ASCII Communication syntax is explained in section [“ASCII Programming Syntax”](#) on page 43.

### COMPUTER OR TERMINAL REQUIREMENTS

---

For fast and easy encoder programming via the serial USB port, Windows®-based RDS Data-Entry Software routines have been supplied on a CD-ROM. This software also may be downloaded from the DEVA Broadcast Ltd. Website. Alternatively, the encoder may be addressed with any computer running a ‘terminal emulation’ program (e.g.: HyperTerminal, normally supplied with Microsoft Windows® XP).

Static PS and other IDs, flags, the Alternative Frequency list and operating mode options are uploaded into non-volatile encoder memory from a PC with USB connection. If Dynamic PS or RadioText messaging is not used, a slogan, phone number or advertising messages can also be entered manually into the 64-character Dynamic PS and RadioText fields. These will be displayed on the radio faceplate as a repetitive scrolling-PS or static RadioText messages. Keep in mind that RadioText and Dynamic PS are separate functions, both of which are simultaneously available with the SmartGen Micro.

Once static data has been uploaded, the encoder may be disconnected from the computer, relocated to another operating point, or reconnected to an alternative data source for dynamic messaging. This may be a hard-disk-based station automation system that provides song title and artist, plus ads or station promos. The automation system must be configured to the encoder’s communication port and programmed to deliver dynamic data in proper syntax as explained by the instructions in section [“ASCII Programming Syntax”](#) on page 43.

## Subcarrier Injection Level

In the *sidechain* mode of operation, the RDS subcarrier is the only signal that appears at the rear-panel RDS OR MPX OUTPUT connector. Because some exciters require a high signal level at auxiliary wideband (SCA) inputs, the RDS signal has been made adjustable to any value between 0 and 3192 mV p-p.

In *loop-through* operation of the encoder, the composite/MPX program signal that is fed to the PILOT OR MPX INPUT appears with unity gain at the RDS OR MPX OUTPUT. A typical peak-to-peak level of the Composite/MPX program signal is up to 10dBu. The same 0-4V RDS subcarrier level range is available in this mode.

### SETTING SUBCARRIER AMPLITUDE

---

Many FM modulation monitors are not capable of making an independent measurement of RDS subcarrier injection level. For this the monitor requires a special subcarrier measurement filter centered at 57kHz. Taking certain limitations into account, however, nearly any conventional mod-monitor may be used to set RDS injection with reasonable accuracy, although this requires a temporary interruption of the audio program... perhaps best done during a maintenance period. Here is the procedure:

1. With the SmartGen Micro encoder disconnected from the exciter, check that the mod-monitor shows total carrier modulation at the accepted 100% figure for program peaks.

2. Disconnect the stereo generator and any SCA or other subcarrier generator from the exciter. Do make sure, however, that the stereo-gen continues to feed a composite/MPX signal to the SmartGen Micro MPX IN connector.

3. Turn the RDS LEVEL control on the rear panel of the SmartGen Micro fully counterclockwise, and then connect the RDS OUT of the SmartGen Micro to a spare wideband subcarrier input of the exciter. As the mod-monitor is downranged to its most sensitive scale, only system noise should be indicated, and at a negligible level if at all.

4. Slowly advance the RDS LEVEL control clockwise. The mod-monitor will begin to register the RDS subcarrier. Set this to the desired injection level, typically 3.5% of total peak modulation (see the following note).

**NOTE:** Many mod-monitors change from a peak to an averaging response on the more sensitive scales in order to present a more meaningful measurement of system noise. Check the manufacturer's documentation to verify the measurement response of your mod-monitor on lower ranges. If response indeed proves to be averaging, the indicated RDS injection will actually be about 4dB lower than the peak value. Consequently, set injection for an indicated 2.2% (with averaging response); this will equate to the desired peak deviation of 3.5%.

5. Reconnect the stereo-gen and any SCA or other subcarrier sources to the exciter. You may now note a very slight increase in total modulation on program peaks. To maintain RDS and any other subcarriers at their proper injection relationship, the output of the stereo generator (i.e.: the audio program level) may have to be turned down slightly so that total modulation is once again at the desired modulation limit.

**NOTE:** The SmartGen Micro encoder will have been programmed with default RDS data at the factory to confirm operation prior to its shipment. Be sure to enter your own RDS data before placing the SmartGen Micro into actual service.



## SUBCARRIER PHASE

In the interest of maintaining optimum carrier modulation by the program signal, the 57kHz RDS subcarrier should be in quadrature with the 19kHz stereo pilot. Both in-phase and *quadrature* relationships are shown here in figures below, respectively. Note that a quadrature relationship yields a slightly lower peak level, which allows the greatest carrier modulation by the program audio signal.

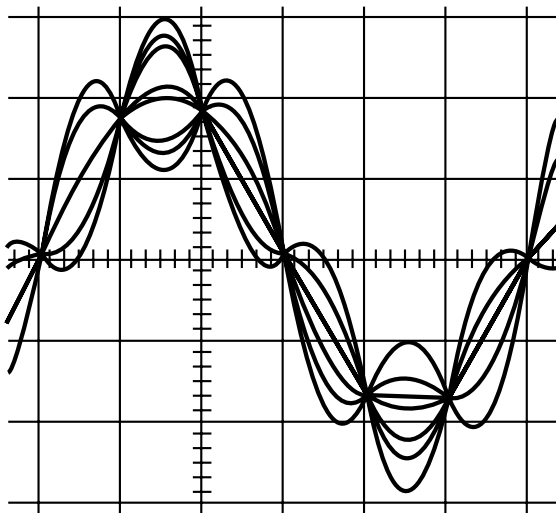

**Subcarrier in-Phase**

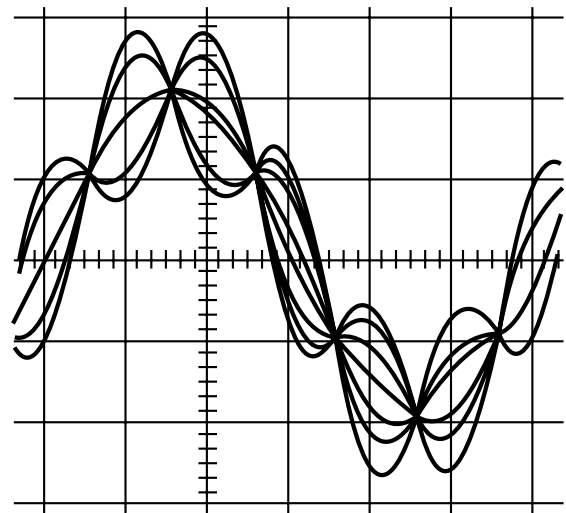

**Subcarrier in Quadrature**

The SmartGen Micro is skillfully and carefully aligned at the factory to ensure that the subcarrier is in quadrature with the stereo pilot, whether the encoder is used in the sidechain or in the loop-through operating mode. Although some stereo generators supply a pilot-sync reference for RDS (usually a TTL-level squarewave), this reference may or may not be in exact phase with the actual stereo pilot component of the composite/MPX signal. For this reason we recommend using the composite/MPX signal for synchronization. In the sidechain mode, the SmartGen Micro simply bridges the output of the stereo generator and does not load or otherwise compromise the composite/MPX signal.

## Programming Options

### **SIMPLIFIED WINDOWS® DATA-ENTRY SOFTWARE**

---

To help get RDS on-air quickly and painlessly, a very simple and intuitive Windows® interface has been included on the CD-ROM that comes with the SmartGen Micro encoder. This can be used by anyone to set the static IDs and flags, to program default entries into the dynamic messaging fields, and to set other operating parameters that affect how data is displayed on the radio faceplate.

# Loading and Running The Simplified Software

## MINIMAL SYSTEM REQUIREMENTS

---

Pentium(R) Processor or Compatible  
Windows XP and above  
512MB RAM  
20MB free hard drive space for installation  
16 or 32-bit graphics color depth  
1024 by 768 pixels screen resolution  
Screen DPI setting to 96 dpi  
Universal Serial Bus 2.0

**NOTE:** To avoid hardware conflicts and encoder connection problems, install the software before attempting to connect the encoder with the computer.

## INSTALLING THE SOFTWARE

---

Insert the supplied CD. Click Start, then My Computer, and then double-click the CD Drive (typically D:). Open the SmartGen Micro folder and double click the installation file to launch the Wizard (shown here) that will guide you through the several installation steps.

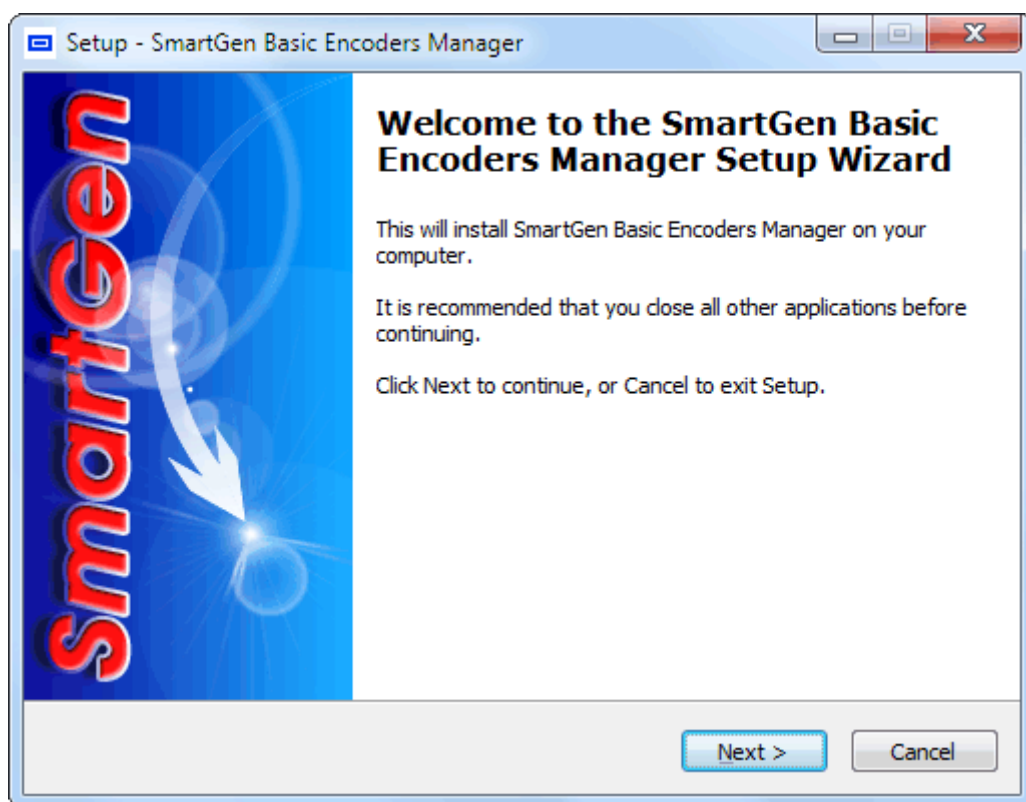

Unless you have a specific reason to make changes, simply accept the default recommendations and click Next> at each step.

Next, follow the procedure below to install the USB driver.

Once the programming software has been installed on the computer, a special USB port driver must also be installed if that particular computer is ever to address the encoder through the front-panel USB port. The station's 'utility laptop' or other machine used for quick, local encoder programming must have both the programming software and the USB driver installed.

When the programming software was installed, the USB driver was put into a folder within the SmartGen Micro program file. With a normal installation (as described above) under Windows<sup>®</sup> XP, the driver will have been located here: My Computer \ Local Disk (C:) \ Program Files \ SmartGen Basic Encoders Manager \ Drivers.

## Installing The USB Port Driver under Windows<sup>®</sup> XP

1. With the SmartGen Micro Encoder powered-up, connect the front-panel USB port to the computer using the cable supplied. This should immediately bring up a New Hardware notification above the computer Taskbar and start the Found New Hardware Wizard. Select "Install from a list or specific location (Advanced)" and then: Next>.



2. This next screen verifies the location of the driver, which should appear automatically in the box as shown. Click: Next>.

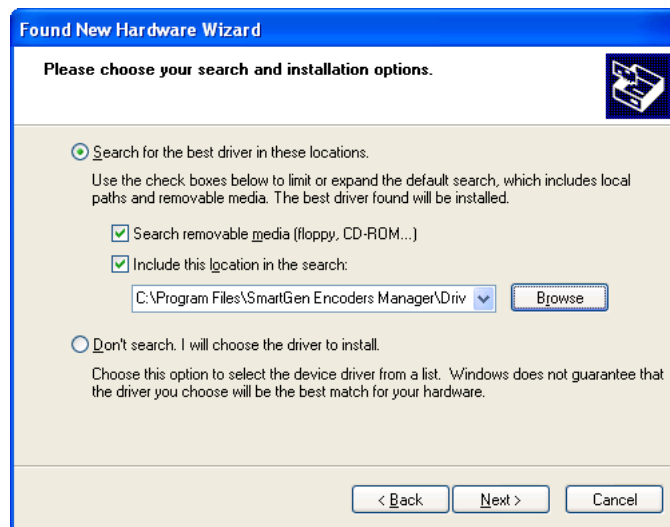

3. Windows® XP will advise that this driver is 'unsigned.' Trust us and click Continue Anyway.

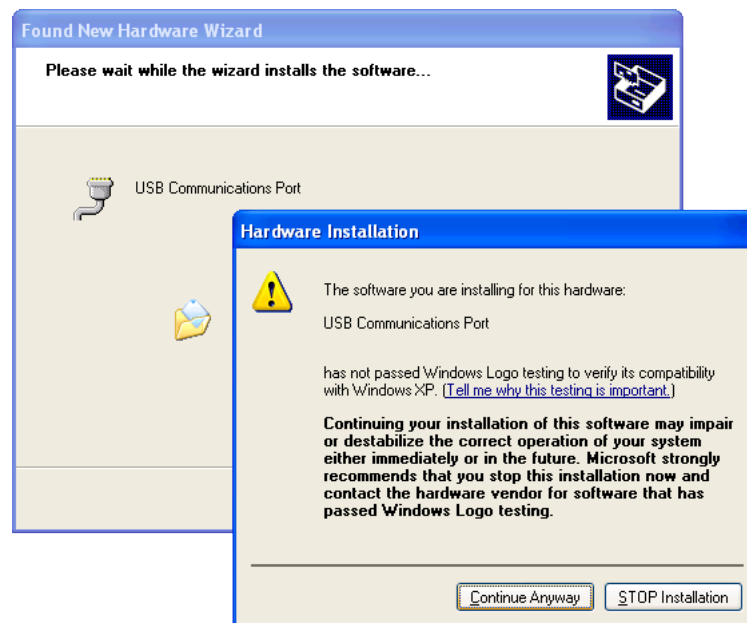

4. The driver will be installed, and a notification that the hardware is ready to use will appear above the Taskbar.

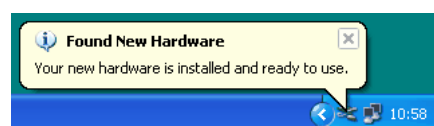

## Installing The USB Port Driver under Windows® 7

1. With the SmartGen Micro powered-up, connect the front-panel USB port to the computer using the cable supplied. This should immediately bring up a “Installing driver” balloon notification above the computer Taskbar. Click on balloon for status or proceed to step 3.

**NOTE:** notification will bring up only once on first device connection. Subsequent connections will not be notified.

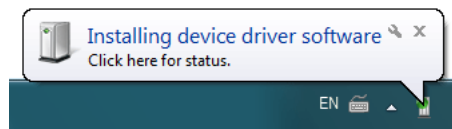

2. Under installation failure, the following status will be shown:

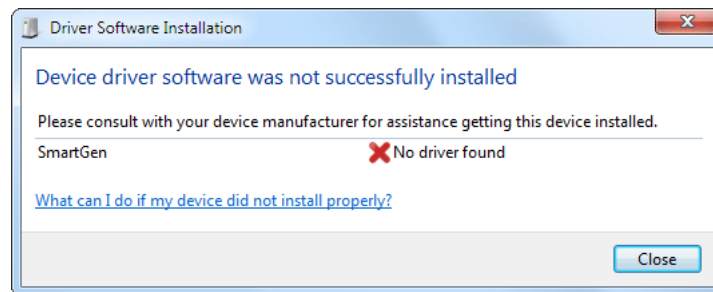

3. Start the Device Manager - Start > Control Panel > Device Manager.

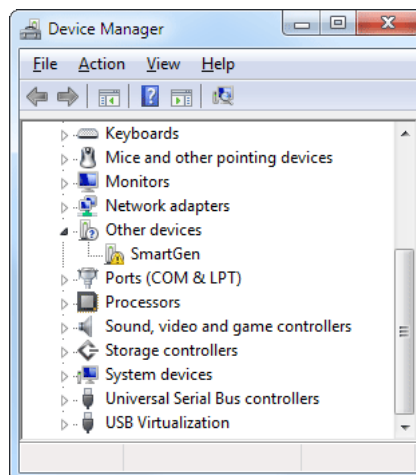

Locate the SmartGen Micro under the “Other devices” section. Right click on it and select “Update Driver Software”. This should bring up Update Driver Wizard. Select “Browse my computer for driver software”.

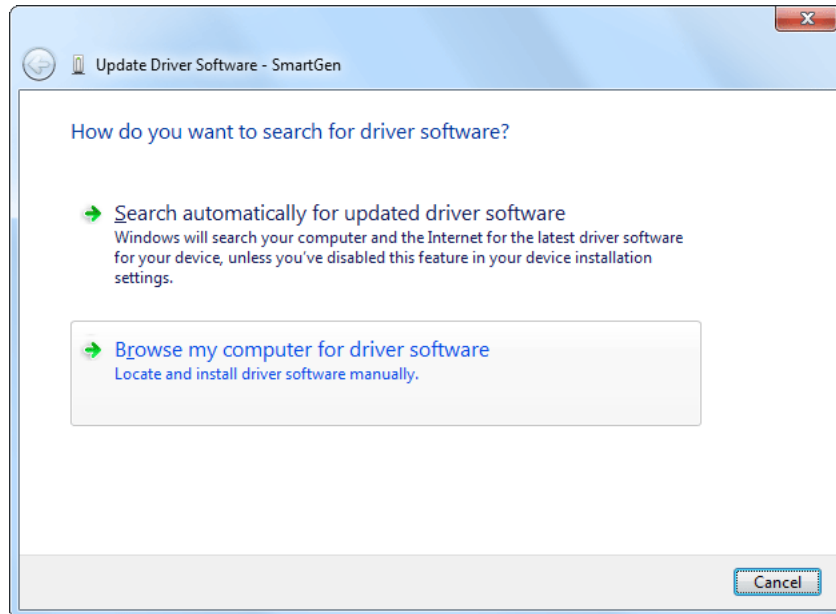

4. Click “Browse...” and select the folder where the drivers reside (typically: C:\Program Files \SmartGen Basic Encoders Manager\Drivers.) Click “Next”.

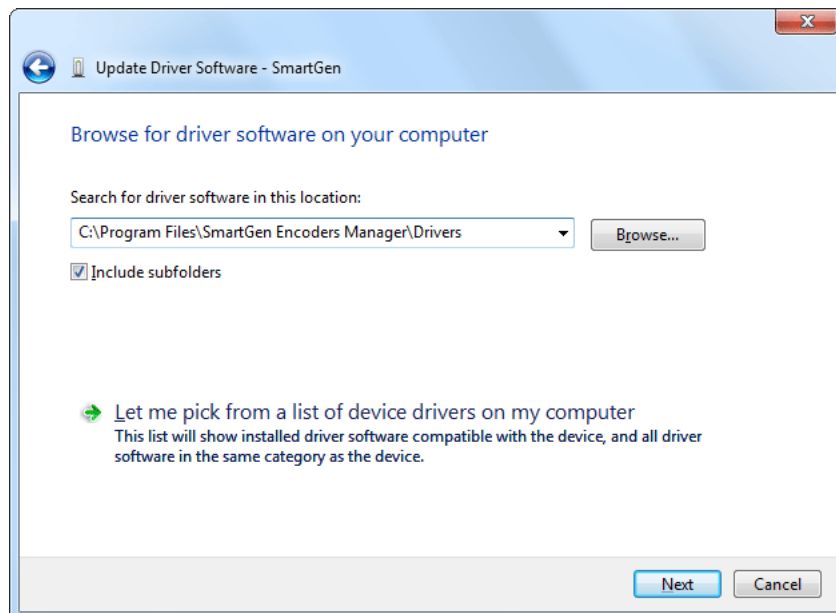

5. Windows<sup>®</sup> 7 will advise that this driver is 'unsigned'. Trust us and click 'Install this driver software anyway'.

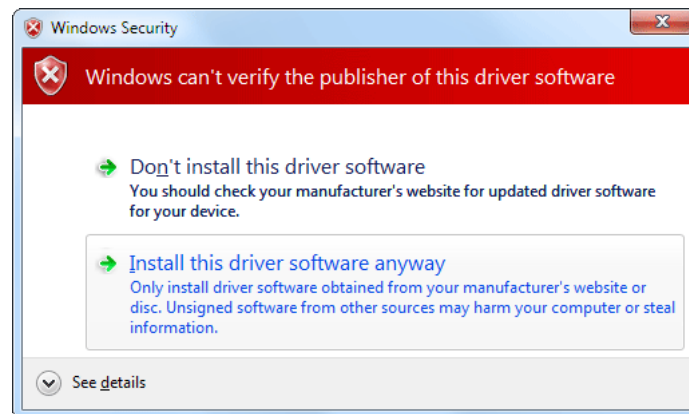

6. Under success the following notification will be shown and the device is ready for use.

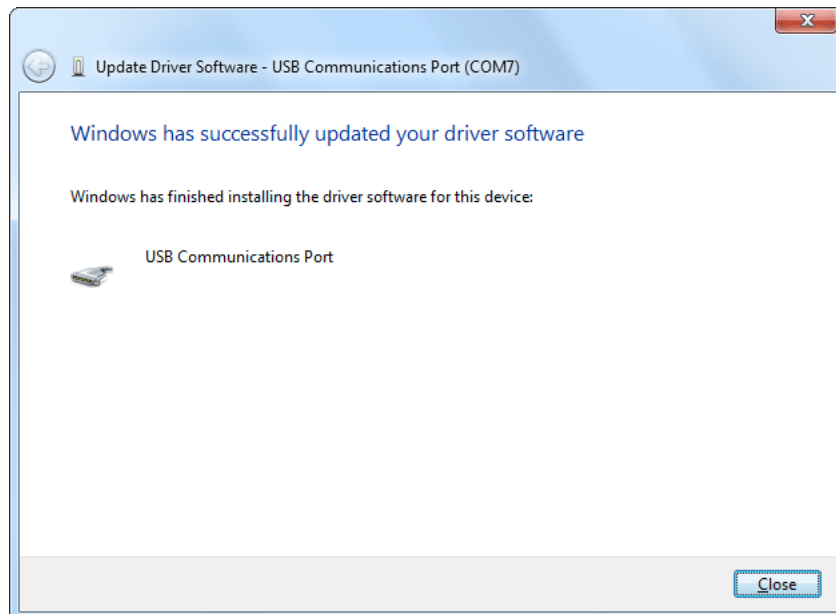

The software installation will have placed an icon on your computer Desktop. Double-click the icon to start the software.



## Using the SmartGen Micro Manager

The software installation will have placed an icon on your computer Desktop. Double-click the icon to start the data-entry software.



Upon startup the application software will look like this:

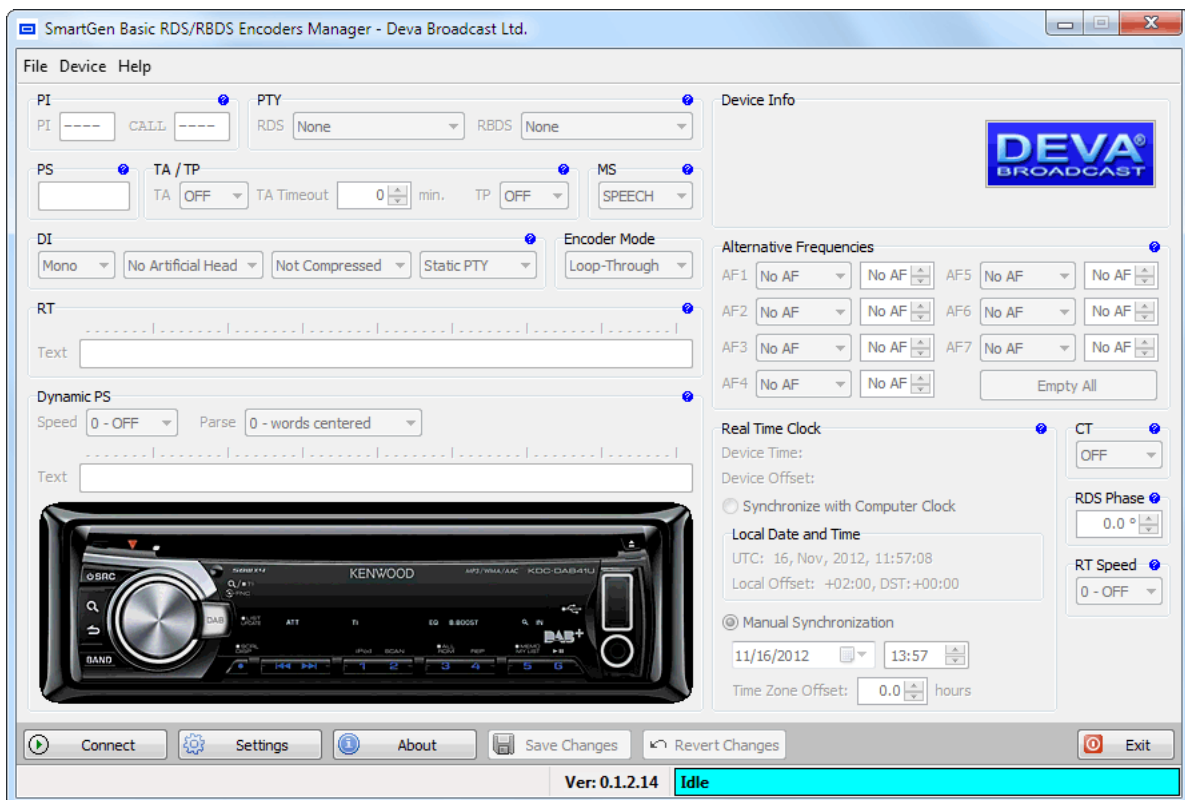

## SENDING & READING DATA

The data resident in the SmartGen Micro encoder memory may be downloaded back onto the software screen without interrupting RDS transmission. This feature is useful for updating only certain fields of RDS data being transmitted without having to re-enter everything. Download by clicking 'Connect' button then select appropriate tab. Make changes in any of the fields, and then upload the back to the encoder with a 'Save Changes' button.

Any change will activate 'Save Changes' and 'Revert Changes' buttons. To upload changes to encoder 'Save Changes' button must be pressed. The Revert Changes (Undo) function will fill back information last read from encoder.

## DEVICE SETTINGS

Before connecting to the SmartGen Micro encoder, software must be configured for the proper communications mode. By pressing the ‘Settings’ button, situated in bottom-left corner, the Settings dialog will appear:

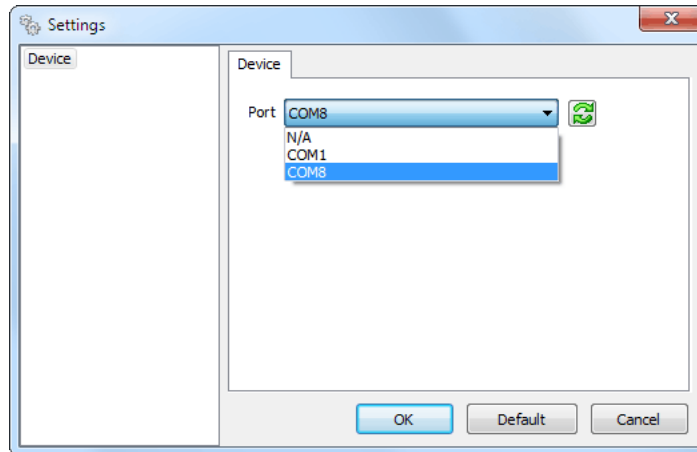

From here, the appropriate connection may be selected regarding to the hardware configuration of the SmartGen Micro device. By pressing the ‘Connect’ button, the Software will attempt to connect to SmartGen Micro device and read its current configuration:

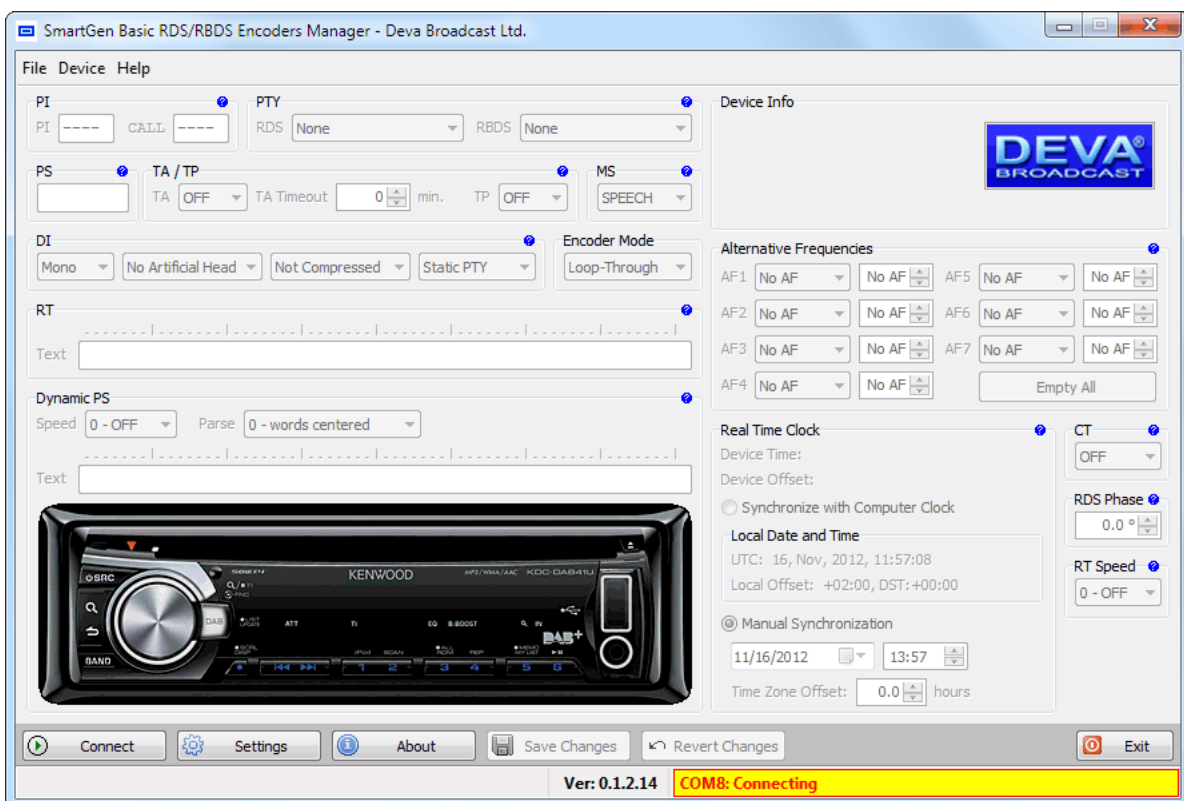

**ATTENTION:** In the bottom-right part of the screen is visible the status of the connection. Any success or failure will be indicated there.

## HARDWARE & RDS CONFIGURATION

Once read, the SmartGen Micro configuration will be visible and ready for editing.

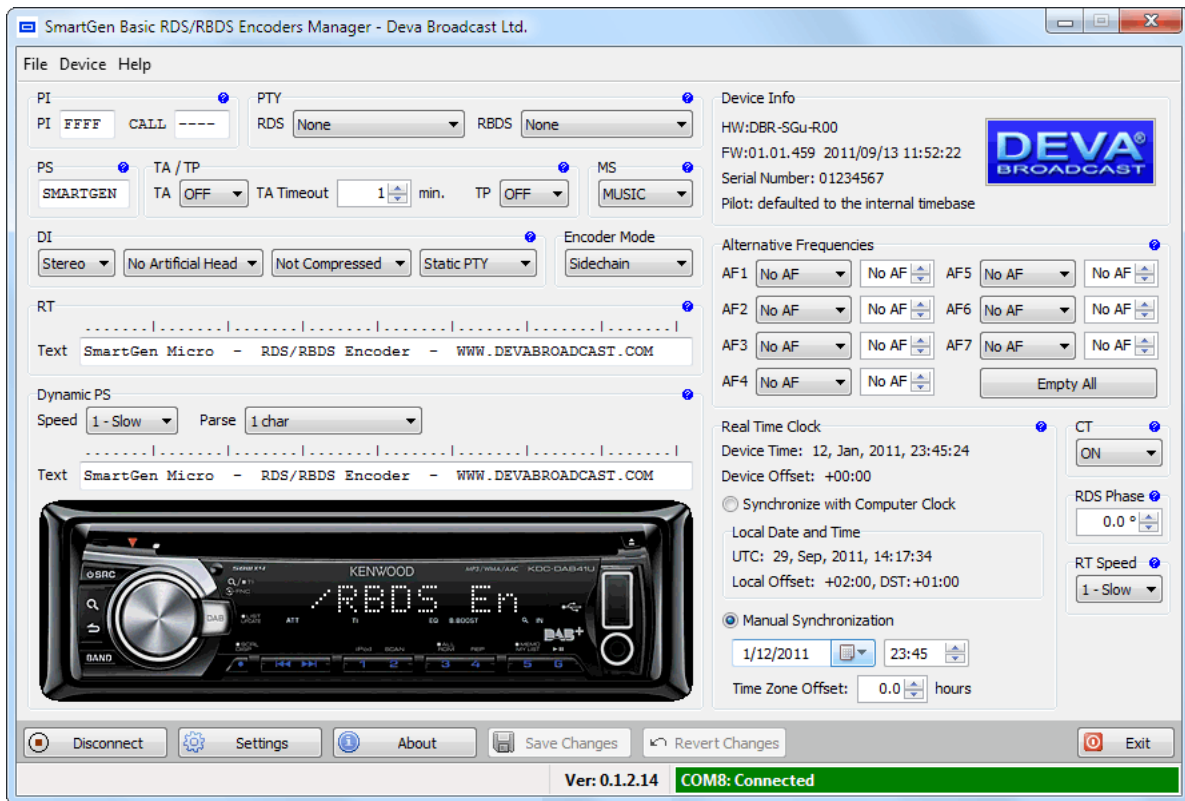

See [“RDS Applications Supported”](#) on page 17 or RDS/RBDS Standard for detailed explanation of each parameter.

### Device Info

is primary for maintenance purposes and reads the hardware characteristics of the SmartGen Micro device.

### Encoder Mode

- The SmartGen Micro encoder must be properly configured for the desired operating mode: sidechain or loop-through before it is installed in the signal path. (see [“Selection of Operating Modes”](#) on page 19)

### RDS Phase

- To set RDS subcarrier phase shift of the RDS subcarrier. (see [“Subcarrier Injection Level”](#) on page 24)

### PI Code Calculator

The PI code is your station’s ‘digital address’. It is a hexadecimal code that is assigned by an appropriate broadcasting authority in most countries, but in the United States the PI code is numerically calculated from the station’s callsign. We have provided a calculator utility within the SmartGen Basic Encoders Manager. An in-depth discussion of the mathematical calculation is given in RDS/RBDS Standard.

To use the PI calculator for US ‘K’ and ‘W’ callsigns, simply enter call letters into the CALL box. The hexadecimal code will automatically be calculated into PI box. If the hexadecimal code for a US station is known, you may enter it under PI, and then the callsign will be calculated automatically into CALL box.

When PI calculator fails to calculate PI or CALL the corresponding box will be filled with ‘----’.

## PTY Selection

**Program Type** identifies the station's programming format from a list. There are two lists, one for the European RDS system and one for the American RBDS specification, hence open the appropriate drop-down list and select suitable PTY.

## TA Timeout

An optional safety feature has been built into the SmartGen Micro to guard against an extended software-activated TA flag. Say, for example, that the TA flag was activated by the software command, and the data link was suddenly lost. No command that deactivates TA flag would be received, and the TA flag would remain raised indefinitely. As this is not a good thing, an automatic timeout option has been included for software-activated TA flags.

Timeout can be set between 1 and 255 minutes. This will automatically deactivate the TA flag after the programmed time has elapsed.

Setting Timeout to 0 will turn off the Timeout feature.

**NOTE:** The Timeout should not be used to define the actual period that the TA flag is raised. The TA flag must be reset to zero immediately following a traffic announcement.

## Dynamic PS

DPS is proprietary setting, which not conform with RDS/RBDS Standard. *Because of driving safety considerations, broadcasters have, from the start, been discouraged from making the PS "dynamic"; that is, to send long messages in a succession of 8-character frames. As a matter of note, it remains a violation of both the CENELEC and the NRSC standards to flash or scroll the PS display. Nevertheless, this nefarious practice of "Scrolling-PS" has become very common, both in the US and abroad.*

The **Dynamic PS** can hold up to 64 characters of text, which can be made to scroll across the RDS radio faceplate. Left undisturbed, the encoder will scroll the same message endlessly.

**Parsing** is the encoder's "smart" mode of message transmission. Parsing breaks messages down into meaningful character groups for efficient display on the 8-character alphanumeric readout common to all RDS receivers.

When **Parse** is set to 0 (words centered) or 9 (words left justified) parsing sends short words together. Longer words, up to and including 8 characters, are sent individually. Words that exceed 8 characters are "sidestepped" through two or more consecutive displays.

When **Parse** is set between 1 and 8 the message is scrolled 1 to 8 characters at a time without divisions into word groups.

Immediate preview of Dynamic PS could be seen on virtual Radio faceplate. Feel free to experiment with different **Text** and **Parse** values.

## CT

- To enable/disable the transmission of type 4A group (Clock Time).

## RTC

- To adjust the Date and Time of the SmartGen Micro device.

- *Synchronize with Computer Clock* - will get Date and Time from computer where software runs.

- *Manual Synchronization* - allows manual editing of the Date and Time values.

## RT Speed

- To adjust the transmission rate of 2A group.

## File Management

All the RDS programming information that is put into the data entry screen may optionally be saved as a file. This is useful when various programming segments throughout the broadcast day have program-specific RDS settings or messages, or for changing advertising or station promos at random.

Data on the screen may be saved as a file before, after, or instead of sending the information to the encoder. Clicking on: File, and then: Save As will prompt you for a location for the file, which will automatically be assigned a .sgm extension. The file may be named in keeping with its content and stored on the computer Desktop or in a dedicated folder of RDS setups.

To import a saved .sgm file onto the screen, click on: File and then: Open. Browse to the Desktop or to a folder where the .sgm file has been saved, and then double-click the file. This brings the RDS programming information onto the screen where it then can be sent to the encoder with the Save Changes button.

## Terminal Configuration

Configuration of the terminal, computer or automation system obviously will depend on parameters placed by hardware and firmware. For simplicity, the encoder ASCII programming illustrations in this section will utilize HyperTerminal, the terminal emulation program by Hillgraeve, Inc., developed for Microsoft and supplied with the Windows® operating system. It is hoped that programming instructions based on terminal emulation will help the programmer understand what ASCII syntax the encoder requires, serving as an example for direct-connection with station automation.

If using HyperTerminal, it's best first to upgrade to the latest version. Download this from [www.hillgraeve.com/hpte](http://www.hillgraeve.com/hpte). The more current product seems to run more smoothly and has text editing features not found in earlier versions.

**NOTE:** Do not connect the SmartGen Micro Encoder until the HyperTerminal program has been configured properly.

HyperTerminal is started under Windows® with the command routine: Start / Programs / Accessories / Communications / HyperTerminal. Double-click: HyperTrm.exe. This brings up the main HyperTerminal screen with a Connection Description window for naming your encoder communications program. How this connection is configured depends on the serial (COM) port will be addressed.

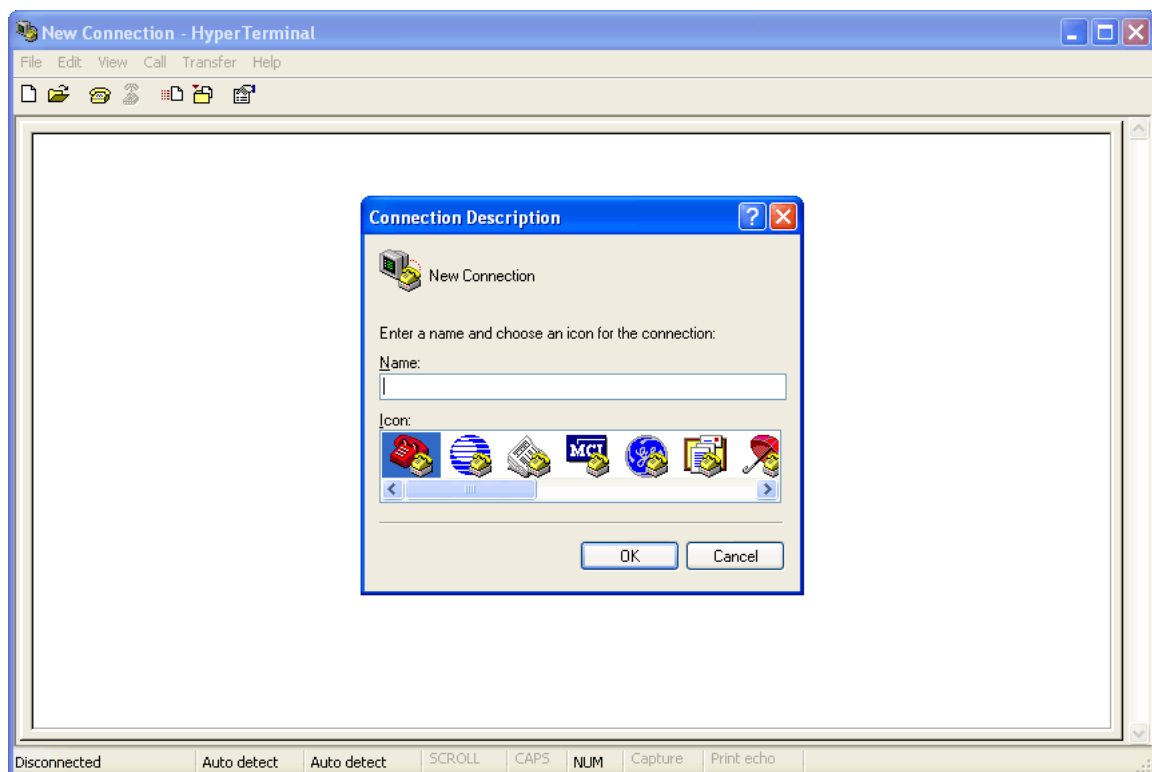

## SERIAL PORT CONFIGURATION

Give the encoder connection a name; we have chosen 'RDS' for this illustration. Click *Connect using* and select appropriate COM port. Click OK.

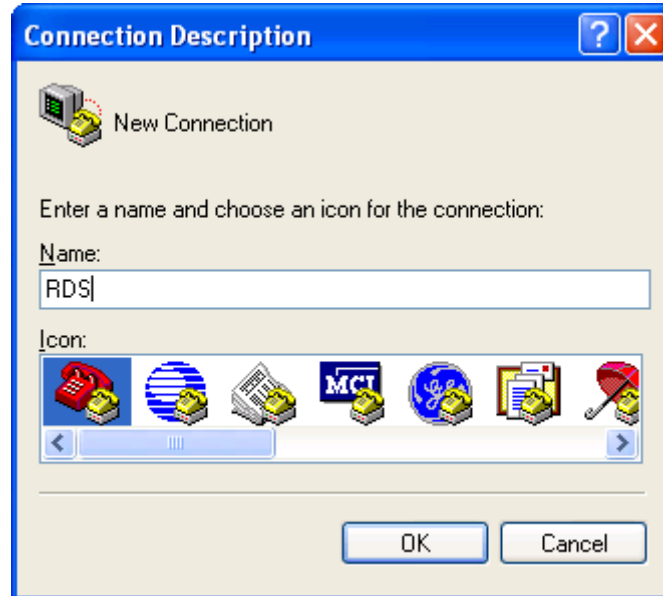

The next window that appears shows selected COM Properties. Here you set the communications parameters as follows: Bits per second: 9600, Data bits: 8, Parity: None, Stop bits: 1, Flow control: None. Check your settings against the screen shot. Click OK to close all boxes and to clear the HyperTerminal data entry screen.

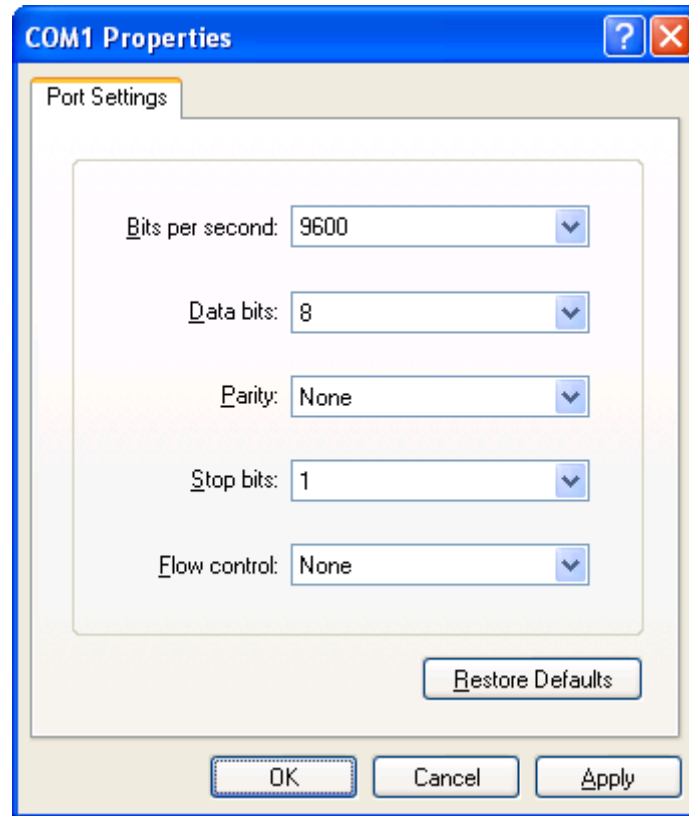

If you experience trouble communicating with the SmartGen Micro, there's a quick and easy check to verify that the computer and the terminal program are functioning normally. With pins 2 and 3 of the DB-9 connector shorted with a screwdriver, whatever is typed on the keyboard should appear on the screen.

When COM port setup is complete the computer may be connected to the encoder COM port. Next, skip to Power-Up, below.



## POWER-UP

Once the encoder is connected and powered-up, communications should be automatic. A notation at the bottom of the HyperTerminal screen verify connection.

Type: ??↵ . This will cause the encoder to send back the contents of all ID, flag and message registers, which (shown here) are the data entered previously (see “Hardware & RDS Configuration” on page 35). ?? can be used at any time to make the encoder ‘spill its guts’. This exercise does not interrupt or interfere with encoder operation.

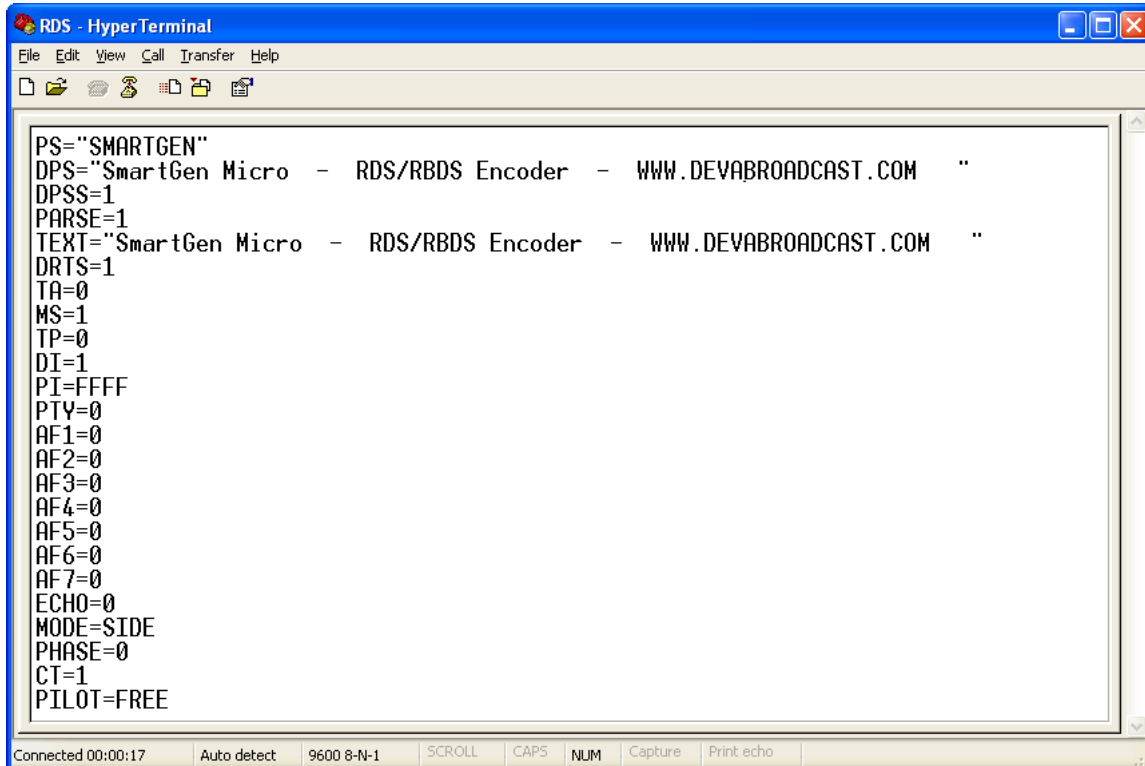

```
RDS - HyperTerminal
File Edit View Call Transfer Help
PS="SMARTGEN"
DPS="SmartGen Micro - RDS/RBDS Encoder - WWW.DEVABROADCAST.COM  "
DPSS=1
PARSE=1
TEXT="SmartGen Micro - RDS/RBDS Encoder - WWW.DEVABROADCAST.COM  "
DRTS=1
TA=0
MS=1
TP=0
DI=1
PI=FFFF
PTY=0
AF1=0
AF2=0
AF3=0
AF4=0
AF5=0
AF6=0
AF7=0
ECHO=0
MODE=SIDE
PHASE=0
CT=1
PILOT=FREE
Connected 00:00:17 Auto detect 9600 8-N-1 SCROLL CAPS NUM Capture Print echo
```

All valid interrogations are followed by: OK; a NO shows that the interrogation was not valid. Any single parameter in a register can be interrogated independently. Simply type the register designation followed by a single question mark. A response shown at the right for the typed command: PI?↵

```
OK
PI?
3D44
OK
-
```

## ECHO

---

It's best for your computer screen to display what has been "echoed" by the encoder as data is entered. Each character typed on the keyboard is sent to the encoder, which turns it back around to be shown on the monitor screen. This round trip gives continuous confirmation of 2-way communications. Typing `ECHO=1` ↵ will provide this round-trip communications verification.

The return data path is not essential, however. The SmartGen Micro will accept programming commands on a receive-only basis. For example, a studio-transmitter radio link (STL) may include 1-way data transmission that could be used to address the encoder.

If double characters appear when typing, your terminal has been configured for local echo. Rather than defeating the echo function of the encoder, local echo should be turned off. This is usually a software command in the terminal or terminal program. Local echo must be used with a 1-way link, however, so that the terminal screen will show what is typed.

The SmartGen Micro has been set to echo as the factory default. The command to turn echo off is `ECHO=0` ↵. To turn echo back on again, type `ECHO=1` ↵.

# ASCII Programming Syntax

## HOW TO TYPE

---

In these programming instructions the exact ASCII syntax to be entered on the keyboard will be given in the font used in this example: `DPS=HELLO↵`. Specifically, the field: DPS, the equal sign and the word HELLO would be typed, followed immediately by pressing the Enter key. We will use ↵ as the symbol for Enter.

## USING ALL-CAPS

---

Programming commands should be typed in ALL CAPS (capital letters) and messages should be kept as simple as possible. Though the encoder will accept lowercase letters and all ASCII punctuation in the DPS and TEXT fields, RDS radio displays have limited character sets and may show ambiguous lowercase characters or gibberish. To assure readability, keep the keyboard Caps Lock key engaged and avoid fancy punctuation. ‘Smileys’ are not a good idea.

## CORRECTING MISTAKES

---

Under HyperTerminal, use the Enter key to drop to a new line, if required, and use either the Backspace key or the keyboard’s directional arrows to navigate within a text entry. Overtyping an entry will automatically replace the previous characters. What is shown on the screen before the Enter key is pressed is what will be sent to the encoder.

## VALIDITY SYMBOLS

The SmartGen Micro ignores ASCII inputs that do not conform to proper formatting rules. This is an important feature when the encoder is connected full-time to station automation. When a valid command is accepted by the encoder, it returns OK to the computer screen. If a data input is properly formatted, but is ambiguous or otherwise not accurate, the screen will display NO. Examples of valid and invalid commands are shown below. Follow programming instructions *exactly* to ensure that commands will be accepted.

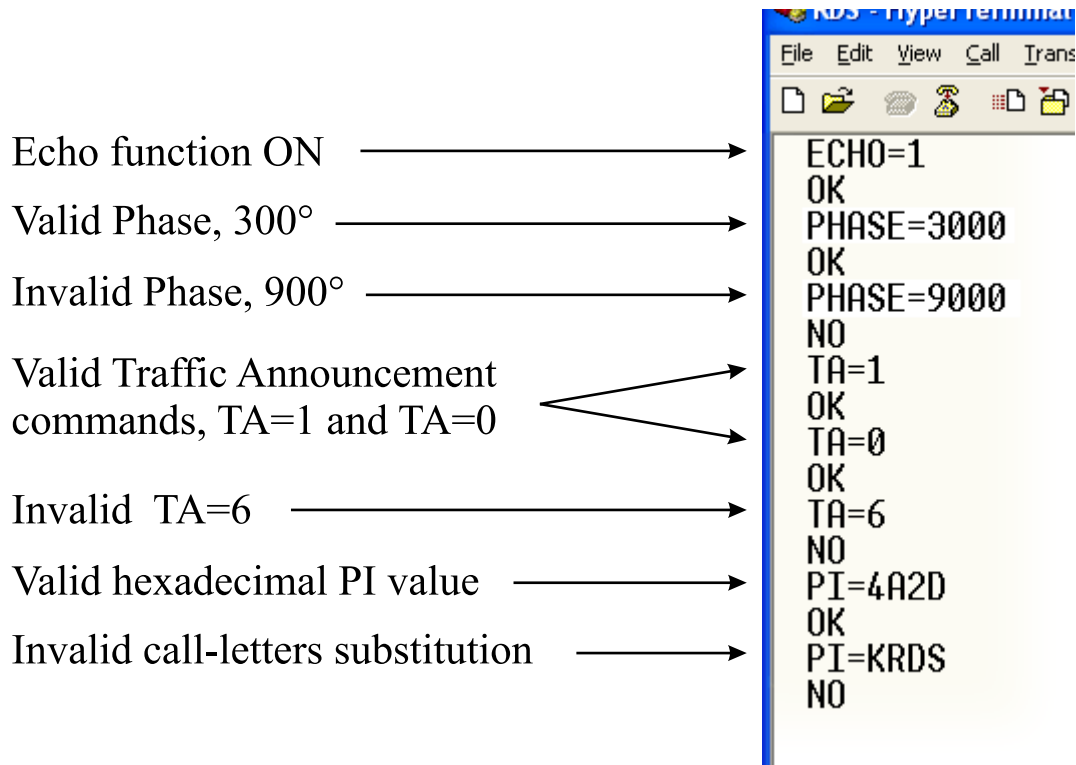

# Encoder Housekeeping Commands

## REGISTER INTERROGATION

---

Typing: ??↵ returns the status of all flag and ID settings and the contents of static message buffers to the screen. This was illustrated in section [“Power-Up” on page 41](#)“.

## ENCODER INITIALIZATION

---

The “initialize” command is invoked by typing: INIT↵. This is used to reestablish encoder operation in the unlikely event of an internal software ‘crash,’ or for any other reason to restore all the factory defaults (see [“Factory Defaults” on page 47](#)). INIT↵ is an emergency recovery command only. It is not necessary to execute INIT↵ prior to updating any encoder programming.

## ENCODER RESET

---

Typing: RESET↵ initiates a ‘hardware reset’ equivalent to turning the encoder off and back on again. This reset command does not clear the registers of programming commands that have been saved as described above.

## FIRMWARE VERSION

---

Type: REV?↵ for a display of the encoder’s firmware version. This might prove important in determining whether differences exist between SmartGen Micro encoders purchased at different times.

## Listing of Encoder Commands and Prompts

Command	Description
PI	Program Identification, 4 digit HEX number (station “digital address”)
PS	Program Service Name, 8 (max) ASCII characters (station “street name”)
DPS	Dynamic PS, 64 (max) ASCII characters (for messaging in PS field)
DPSS	Dynamic PS speed, 0 to 9 (0 = OFF, 1 = SLOW, 9 = FAST)
PTY	Program Type, 0 to 31 (describes station format)
TP	Traffic Program, 0 or 1 (0 = NO, 1 = YES)
TA	Traffic Alert, 0 or 1 (0 = flag OFF, 1 = flag ON)
DI	Decoder Information, 0 to 15
MS	Music/Speech, 0 or 1 (0 = speech-only, 1 = music)
TEXT	RadioText, 64 (max) ASCII characters
DRTS	Dynamic RadioText Speed, 0 to 9 (0 = OFF; 1 = SLOW 9 = FAST)
AFx	Alternative Frequencies List using method A, where x is from 1 to 7 0 = blank; 1 to 204 = “channel” in 87.6MHz to 107.9MHz <b>Example:</b> AF1=10
TATIME	TA Timeout, 0 to 255 minutes (0 = OFF)
ECHO	Command Echo, 0 or 1 (0 = ECHO OFF, 1 = ECHO ON)
PARSE	Dynamic PS Method, 0 to 9 0 = centered, 9 = left justified, 1-8 = N characters at a time
MODE	Operating Mode, 0 or 1 (LOOP or SIDE) 0 = loop-through, 1 = sidechian
TIME	UTC Time, HH:MM:SS (HH=hour, MM=Minutes, SS=Seconds)
DATE	Date, DD.MM.YY (DD=Day, MM=Month, YY=YEAR)
OFFSET	Local Time offset, -15:30 to +15:30, in multiples of half hours
PHASE	RDS subcarrier Phase in degrees, 0 to 3599, 1 = 0.1 degree
CT	Switch transmission of 4A group ON or OFF, 0 = OFF, 1 = ON
Use ‘=’ to SET parameter value, e.g.: PI=1234	
Use ‘?’ to GET parameter value, e.g.: TIME?	
SPECIAL COMMANDS	
Command	Description
??	Returns all data in encoder memory
SER?	Returns device serial number
REV?	Returns firmware & hardware revision numbers
PILOT?	Returns the Status of the 19 kHz PLL. LOCK - locked to the 19kHz stereo pilot signal. FREE - defaulted to the internal timebase
RESET	Resets the encoder as if AC power were cycled off and on
INIT	Initializes the encoder to all factory defaults
CLS	Clears the Terminal Screen
Response	Meaning
OK	Command received by encoder properly formatted and understood
NO	Command properly formatted but data not understood
(NONE)	Data sent is ignored by the encoder

**DON'T FORGET** that all the static RDS registers, including simple scrolling messages, can be entered or changed easily through the Windows® data entry screens.

## Factory Defaults

### GENERAL SETTINGS

---

RDS Phase	0.0°
Output Mode	Sidechain
CT	On
Local Time Offset	0

### RDS SETTINGS

---

PI	FFFF
PTY	None
PS	SMARTGEN
TA	OFF
TP	OFF
TA Timeout	1
MS	Music
DI	1
RT	SmartGen Micro - RDS/RBDS Encoder - WWW.DEVABROADCAST.COM
Dynamic PS	SmartGen Micro - RDS/RBDS Encoder - WWW.DEVABROADCAST.COM
DPS Speed	1 (slow)
Parse	1 char
AF List	Empty
DRT Speed	1 (slow)

## PRODUCT REGISTRATION CARD

- All fields are required, or warranty registration is invalid and void

Your Company Name \_\_\_\_\_

Contact \_\_\_\_\_

Address Line 1 \_\_\_\_\_

Address Line 2 \_\_\_\_\_

City \_\_\_\_\_

State/Province \_\_\_\_\_ ZIP/Postal Code \_\_\_\_\_

Country \_\_\_\_\_

E-mail \_\_\_\_\_ Phone \_\_\_\_\_ Fax \_\_\_\_\_

Which DEVA Broadcast Ltd. product did you purchase? \_\_\_\_\_

\_\_\_\_\_  
\_\_\_\_\_

Product Serial # \_\_\_\_\_

Purchase date \_\_\_\_ / \_\_\_\_ / \_\_\_\_

Installation date \_\_\_\_ / \_\_\_\_ / \_\_\_\_

\_\_\_\_\_  
Your signature\*

\*Signing this warranty registration form you are stating that all the information provided to DEVA Broadcast Ltd. are truth and correct. DEVA Broadcast Ltd. declines any responsibility for the provided information that could result in an immediate loss of warranty for the above specified product(s).

**Privacy statement: DEVA Broadcast Ltd. will not share the personal information you provide on this card with any other parties.**



## WARRANTY TERMS AND CONDITIONS

**I. TERMS OF SALE:** DEVA Broadcast Ltd. products are sold with an understanding of “full satisfaction”; that is, full credit or refund will be issued for products sold as new if returned to the point of purchase within 30 days following their receipt, provided that they are returned complete and in an “as received” condition.

**II. CONDITIONS OF WARRANTY:** The following terms apply unless amended in writing by DEVA Broadcast Ltd.

**A.** The Warranty Registration Card supplied with this product must be completed and returned to DEVA Broadcast Ltd. within 10 days of delivery.

**B.** This Warranty applies only to products sold “as new.” It is extended only to the original end-user and may not be transferred or assigned without prior written approval by DEVA Broadcast Ltd.

**C.** This Warranty does not apply to damage caused by improper mains settings and/or power supply.

**D.** This Warranty does not apply to damage caused by misuse, abuse, accident or neglect. This Warranty is voided by unauthorized attempts at repair or modification, or if the serial identification label has been removed or altered.

**III. TERMS OF WARRANTY:** DEVA Broadcast Ltd. products are warranted to be free from defects in materials and workmanship.

**A.** Any discrepancies noted within TWO YEARS of the date of delivery will be repaired free of charge, or the equipment will be replaced with a new or remanufactured product at DEVA Broadcast Ltd. option.

**B.** Parts and labor for factory repair required after the one-year Warranty period will be billed at prevailing prices and rates.

### **IV. RETURNING GOODS FOR FACTORY REPAIR:**

**A.** Equipment will not be accepted for Warranty or other repair without a Return Authorization (RA) number issued by DEVA Broadcast Ltd. prior to its return. An RA number may be obtained by calling the factory. The number should be prominently marked on the outside of the shipping carton.

**B.** Equipment must be shipped prepaid to DEVA Broadcast Ltd.. Shipping charges will be reimbursed for valid Warranty claims. Damage sustained as a result of improper packing for return to the factory is not covered under terms of the Warranty and may occasion additional charges.

## APPENDIX A

### PTY Code Description Used in RBDS Mode – North America

PTY	Short Name	Description
1	News	News reports, either local or network in origin.
2	Information	Programming that is intended to impart advice.
3	Sports	Sports reporting, commentary, and/or live event coverage, either local or network in origin.
4	Talk	Call-in and/or interview talk shows either local or national in origin.
5	Rock	Album cuts.
6	Classic Rock	Rock oriented oldies, often mixed with hit oldies, from a decade or more ago.
7	Adult Hits	An up-tempo contemporary hits format with no hard rock and no rap.
8	Soft Rock	Album cuts with a generally soft tempo.
9	Top 40	Current hits, often encompassing a variety of rock styles.
10	Country	Country music, including contemporary and traditional styles.
11	Oldies	Popular music, usually rock, with 80% or greater non-current music.
12	Soft	A cross between adult hits and classical, primarily non-current softrock originals.
13	Nostalgia	Big-band music.
14	Jazz	Mostly instrumental, includes both traditional jazz and more modern “smooth jazz.”
15	Classical	Mostly instrumentals, usually orchestral or symphonic music.
16	Rhythm and Blues	A wide range of musical styles, often called “urban contemporary.”
17	Soft R and B	Rhythm and blues with a generally soft tempo.
18	Foreign Language	Any programming format in a language other than English.
19	Religious Music	Music programming with religious lyrics.
20	Religious Talk	Call-in shows, interview programs, etc. with a religious theme.
21	Personality	A radio show where the on-air personality is the main attraction.
22	Public	Programming that is supported by listeners and/or corporate sponsors instead of advertising.
23	College	Programming produced by a college or university radio station.
24-28	Unassigned	
29	Weather	Weather forecasts or bulletins that are non-emergency in nature.
30	Emergency Test	Broadcast when testing emergency broadcast equipment or receivers. Not intended for searching or dynamic switching for consumer receivers. Receivers may, if desired, display “TEST” or “Emergency Test”.
31	Emergency	Emergency announcement made under exceptional circumstances to give warning of events causing danger of a general nature. Not to be used for searching - only used in a receiver for dynamic switching.

**NOTE:** These definitions can differ slightly between various language versions.

## APPENDIX B

### PTY Code Description Used in RDS Mode – Europe, Asia

PTY	Short Name	Description
1	News	Short accounts of facts, events and publicly expressed views, reportage and actuality.
2	Current affairs	Topical program expanding or enlarging upon the news, generally in different presentation style or concept, including debate, or analysis.
3	Information	Program the purpose of which is to impart advice in the widest sense.
4	Sport	Program concerned with any aspect of sport.
5	Education	Program intended primarily to educate, of which the formal element is fundamental.
6	Drama	All radio plays and serials.
7	Culture	Programs concerned with any aspect of national or regional culture.
8	Science	Programs about the natural sciences and technology.
9	Varied	Used for mainly speech-based programs usually of light-entertainment nature, not covered by other categories. Examples include: quizzes, games, personality interviews.
10	Pop	Commercial music, which would generally be considered to be of current popular appeal, often featuring in current or recent record sales charts.
11	Rock	Contemporary modern music, usually written and performed by young musicians.
12	Easy Listening	Current contemporary music considered to be “easy-listening”, as opposed to Pop, Rock or Classical, or one of the specialized music styles, Jazz, Folk or Country. Music in this category is often but not always, vocal, and usually of short duration.
13	Light classics	Classical Musical for general, rather than specialist appreciation. Examples of music in this category are instrumental music, and vocal or choral works.
14	Serious classics	Performances of major orchestral works, symphonies, chamber music etc., and including Grand Opera.
15	Other music	Musical styles not fitting into any of the other categories. Particularly used for specialist music of which Rhythm & Blues and Reggae are examples.
16	Weather	Weather reports and forecasts and Meteorological information.
17	Finance	Stock Market reports, commerce, trading etc.
18	Children’s programs	For programs targeted at a young audience, primarily for entertainment and interest, rather than where the objective is to educate.
19	Social Affairs	Programs about people and things that influence them individually or in groups. Includes: sociology, history, geography, psychology and society.
20	Religion	Any aspect of beliefs and faiths, involving a God or Gods, the nature of existence and ethics.
21	Phone In	Involving members of the public expressing their views either by phone or at a public forum.
22	Travel	Features and programs concerned with travel to near and far destinations, package tours and travel ideas and opportunities. Not for use for Announcements about problems, delays, or roadworks affecting immediate travel where TP/TA should be used.
23	Leisure	Programs concerned with recreational activities in which the listener might participate. Examples include, Gardening, Fishing, Antique collecting, Cooking, Food & Wine etc.
24	Jazz Music	Polyphonic, syncopated music characterized by improvisation.
25	Country Music	Songs which originate from, or continue the musical tradition of the American Southern States. Characterized by a straightforward melody and narrative story line.
26	National Music	Current Popular Music of the Nation or Region in that country’s language, as opposed to International ‘Pop’ which is usually US or UK inspired and in English.
27	Oldies Music	Music from the so-called “golden age” of popular music.
28	Folk Music	Music which has its roots in the musical culture of a particular nation, usually played on acoustic instruments. The narrative or story may be based on historical events or people.
29	Documentary	Program concerned with factual matters, presented in an investigative style.
30	Alarm Test	Broadcast when testing emergency broadcast equipment or receivers. Not intended for searching or dynamic switching for consumer receivers.. Receivers may, if desired, display “TEST” or “Alarm Test”.
31	Alarm	Emergency announcement made under exceptional circumstances to give warning of events causing danger of a general nature. Not to be used for searching - only used in a receiver for dynamic switching.